



Station User Guide

December 2004 - Issue 1.6

P/N: 3552-00

Issue	Release Date	Changes
1.0	12-02	Initial Release
1.1	2-03	Minor revisions for correctness & clarity.
1.2	7-03	Minor revisions for correctness & clarity.
1.3	10-03	Minor revisions for correctness & clarity.
1.4	5-04	<input type="checkbox"/> Includes Trunk-to-Trunk Transfer procedure. <input type="checkbox"/> Revises Attendant Unavailable feature to reflect increase of Attendant station capacity from 3 to 6. <input type="checkbox"/> System allows 8- and 30-button telephone instruments to be used.
1.5	8-04	<input type="checkbox"/> An In and Out Button feature is added. <input type="checkbox"/> A Page Block option is added to DND button. <input type="checkbox"/> A UCD Wrapup End feature is added. <input type="checkbox"/> A Hard-Drive-based Voice Mail Quick Reference Menu is added.
1.6	12-04	Minor revisions for correctness and clarity; deleted outdated graphics.

LIFE SUPPORT APPLICATIONS POLICY

VODAVI Technology, Inc. products are not authorized for and should not be used within Life Support applications. Life Support systems are equipment intended to support or sustain life and whose failure to perform when properly used in accordance with instructions provided can be reasonably expected to result in significant personal injury or death.

VODAVI Technology, Inc. warranty is limited to replacement of defective components and does not cover injury to persons or property or other consequential damages.

“WARNING: Handling the cord on this product will expose you to lead, a chemical known to the State of California to cause [cancer, and] birth defects or other reproductive harm. ***Wash hands after handling.*”**

Copyright © 2003 VODAVI Technology, Inc.

All Rights Reserved

This material is copyrighted by VODAVI Technology, Inc. Any unauthorized reproductions, use or disclosure of this material, or any part thereof, is strictly prohibited and is a violation of the Copyright Laws of the United States (17 U.S.C. Section 101 et. seq.).

VODAVI reserves the right to make changes in specifications at any time and without notice. The information furnished by VODAVI in this material is believed to be accurate and reliable, but is not warranted to be true in all cases.

STARPLUS and *STS* are registered trademarks of
VODAVI Technology, Inc.

mj/2004



FIXED FEATURE BUTTONS

- **CAMP ON** -- enables you to alert a busy party that an outside line is on hold for them.
- **CONF (CONFERENCE)** -- used to establish and build conference calls.
- **FLASH** -- lets you terminate an outside call and restore dial tone without having to hang up the handset. It is also used to transfer calls behind a PBX or Centrex within those systems.
- **FWD (FORWARD)** -- allows you to forward your calls to another station.
- **HOLD** -- enables you to place an outside caller on hold.
- **H-T-P** -- allows you to select the ICM signaling mode: Handsfree, Tone, or Privacy.
- **MSG (MESSAGE WAIT)** -- allows you to initiate a message waiting indication at a station(s) that is: Busy, Unattended, or in Do Not Disturb.

CALL FORWARDING

1. Press the FWD button or dial [640].
2. Dial the desired Call Forward code:
[6] = All Calls [7] = No Answer
[8] = Busy [9] = Busy/No Answer
3. Dial the station number where calls are to be forwarded. Confirmation tone sounds.
4. Replace the handset or press ON/OFF button.

ESTABLISHING A CONFERENCE

>> *Only those stations that have Conference enabled will be allowed to initiate a Conference call.*

1. Lift the handset.
2. Select intercom station or dial desired outside party. When called party answers, press CONF.
3. Add the next conference party by selecting another outside line or intercom station.
4. Press CONF button again and repeat previous step in a cycle, until all parties are contacted.
5. When the last party answers, press the CONF button twice. All parties will be connected.

TERMINATING A CONFERENCE

To end a *Supervised Conference*, the conference initiator replaces the handset or presses ON/OFF.

To end an *Unsupervised Conference*, press the flashing CONF button while on-hook.

A Message Waiting Callback request that is left at your station is indicated by a flashing MSG WAIT LED.

- **MUTE** -- allows you to switch the built-in microphone on or off when using the speakerphone, or the handset microphone when using the handset.
- **ON/OFF** -- enables you to make a call without lifting the handset. It also turns the telephone on and off when using the speakerphone.
- **SPEED** -- provides you with access to speed dialing, save number redial and last number redial. This button is also used to access flexible button programming.
- **TRANS (TRANSFER)** -- lets you transfer an outside call from one station to another.
- **VOLUME BAR** -- allows you to adjust the volume for your speakerphone and handset.

UNSCREENED TRANSFER

1. Press TRANS button and dial station number.
2. When the called extension begins to signal, hang up to transfer the call.
3. Replace the handset or press ON/OFF button.

SCREENED TRANSFER

While connected to an outside line:

1. Press the station button where the call is to be transferred (*if programmed on your telephone*),
-or-
Press TRANS and dial desired station number.
(The called extension is signaled according to their intercom signal switch position.)
2. When extension answers, announce transfer.
3. Hang up to complete the transfer.

LEAVING A MSG WAITING INDICATION

If you dial a station that is busy, unattended, or in Do Not Disturb, you can leave a message waiting indication.

1. Press the ON/OFF button.
2. Dial the desired intercom station. A busy tone or DND tone is heard.
3. Press the MSG button. The called party's MSG button LED will flash slowly.
4. Press the ON/Off button to end the call.



PLACING AN OUTSIDE LINE ON HOLD

- If your system is programmed for *Exclusive Hold Preference*, press the HOLD button once for Exclusive Hold or twice for System Hold.
- If your system is programmed for *System Hold Preference*, press the HOLD button once for System Hold or twice for Exclusive Hold.

STORING SPEED NUMBERS

1. Press the SPEED button twice.
2. Dial the speed bin location.
 - 9000 to 9019 = Station speed numbers
 - 9020 to 9099 = System speed numbers
3. Dial the desired telephone number.
4. Press the SPEED button.
5. Press ON/OFF to end programming.

To clear an existing speed bin:

1. Press the SPEED button twice.
2. Dial the speed bin location.
3. Press SPEED again. Confirmation tone sounds.

DIALING A SPEED NUMBER

1. Press SPEED and dial the speed bin location, -or- Press the preprogrammed speed bin button.
 - 9000 to 9019 = Station speed numbers
 - 9020 to 9099 = System speed numbers
2. When the called party answers, pick up the handset or use the speakerphone.

DIRECTORY DIALING

Users with display telephones may view a list of individuals on the telephone system and have the system automatically dial that person. Directory Dialing may also be used to transfer a call from one station to another.

1. Dial the Directory List dial code [680], -or- Press the DIRECTORY DIAL flexible button.
2. Press a button on the keypad once, twice, or three times, that represents the letter of the alphabet, to begin viewing the list of names.
3. Scroll through the Directory List to select a name; press [*] to display the next entry and [#] for the previous entry.
4. Press the SPEED button at the desired name to automatically dial the destination station or outside phone number (via Speed Dial).

To transfer a call using directory dialing:

1. Press the TRANS button.
 2. Dial the Directory Dial Code [680], -or- Press the DIRECTORY DIAL flexible button.
 3. Press the digit associated with the person's name. When the name displays, press SPEED button to automatically dial the station.
 4. Press ON/OFF button to complete transfer.
- >> Calls can only be transferred to internal stations.

PROGRAMMING FLEXIBLE BUTTONS

1. Press the SPEED button twice.
2. Press the flexible button to be programmed.
3. Dial the desired code from the following chart. Confirmation tone sounds.
4. Press the ON/OFF button.

All Call Page (<i>Internal & External</i>)	700
Background Music	632
Call Back	622
Call Park Location (<i>System</i>)	43+[C]
Call Park Location (<i>Station</i>)	439+[XXX]
Call (Park) Pickup	#6+[XXX]
Caller ID Review (<i>Answered</i>)	659
Caller ID Review (<i>Unanswered</i>)	635
Directory Dial	680
Do Not Disturb	631
Extension Numbers	100-149
External Page Zone	761
Last Number Redial	[SPEED]+[#]
Line Queue	621
Personal Park	438
Speed Dial Access	[SPEED]+[YYYY]
Save Number Redial	[SPEED]+[*]
VM Group Pilot Numbers	44 [V]

C = Call Park Location (0-7)
 V = Voice Mail Group Number (0-7)
 XXX = Station Extension Numbers
 YYYY = Speed Dial Bin Numbers
 (Station=9000-9019 / System=9020-9099)

To erase a flexible button:

1. Press the SPEED button twice.
2. Press the flexible button to be erased.
3. Press FLASH . Confirmation tone sounds.
4. Press the ON/OFF button.

Contents

911 Alert.....	2
Account Codes	3
Using Account Codes	3
Verified Account Codes	3
Account Codes - Traveling COS (Verified).....	4
Answering Machine Emulation	5
Notification Methods	5
Attendant Features.....	6
Attendant Clear Alarm	6
Attendant CO Line External (Off-Net) Forward	7
Attendant Custom Message	7
Attendant Day/Night/Special.....	8
Attendant Directory List Programming.....	9
Attendant Disable Outgoing CO Line	12
Attendant Override	13
Attendant Setting Time and Date.....	13
Attendant Speed Dial - System Storing	14
Attendant Unavailable	15
Attendant Voice Mail Alarm Clear.....	15
Background Music (Optional)	16
Call Back.....	17
Call Coverage	18
Call Forward.....	19
Call Forward - External (Off-Net)	20
Call Forward - Follow Me.....	21
Call Park.....	23
Call Park - Personal.....	23
Call Park - Station	24
Call Park - System.....	25
Call Pickup.....	26
Directed Call Pickup	26
Group Call Pickup	27
Call Transfer	28
Executive/Secretary Transfer	28
PBX/Centrex Transfer	28
Screened Transfer	29
Transfer Search	29
Unanswered CO Call Transfer.....	30
Unscreened Transfer.....	30

Trunk-To-Trunk Transfer.....	30
Caller ID Display	31
Caller ID Display (Answered Calls)	31
Caller ID Display (Unanswered Calls)	32
Caller ID Name/Number	33
Calling Forward Override.....	33
Calling Station Handsfree Mode Override.....	34
Calling Station Tone Mode Override	34
Camp On.....	35
CO Line - Access	36
CO Line Queue.....	37
Conference.....	38
Conference Combinations	38
Conference Procedures	38
Dial-By-Name	41
Directory Dial	42
Do Not Disturb / Page Block.....	44
Executive Override	46
Flash	46
Flash Key on Intercom.....	46
Flexible Button Programming	47
Group Listening	48
Headset Mode	48
In and Out Button.....	50
Intercom	50
Using an Intercom Button	50
Intercom Calls	51
Intercom Transfer	53
Keypad Mode.....	54
Last Number Redial.....	55
LCR Operation.....	56
Loop Key	57
Mailbox Buttons.....	57
Message Wait	58
Modem	59
Voice Mail Modem Access	59
Telephone System Modem Access.....	59
Mute	60
Name In Display	60

Night Service	61
Off-Hook Voice Over (OHVO)	62
Outside Calls.....	64
Placing an Outside Line on Hold.....	64
Answering a Recall.....	64
Answering an Outside Call	64
Placing an Outside Call	64
Paging.....	65
Paging - Meet Me.....	66
Personalized Messages.....	66
Pre-assigned Messages.....	66
Custom Messages.....	67
Date and Time Entry Messages.....	68
Scrollable Canned Messages	70
Personal Messages Flexible Button.....	71
PBX/Centrex Codes on a Flex Button	72
Release Button.....	72
Redial	72
Last Number Redial	72
Save Number For Redial	73
Redial a Saved Number.....	73
Repeat Redial	73
Ring Down / Hot Line / Off-Hook Preference	74
Ring Tone	76
School Zone.....	77
Speakerphone	79
Speed Dial.....	79
System Speed Dial Access	81
Station/Port Fixed Number	81
Station Relocate	82
Text Messaging (Silent Response).....	82
Uniform Call Distribution.....	84
UCD Calls In Queue Display	84
UCD Available/Unavailable Mode	85
UCD Overflow Station Forward	85
UCD Wrapup End.....	86
Universal Day/Night Answer	86
Voice Mail	87
Call Forwarding to Voice Mail Groups.....	87
Retrieving Voice Messages.....	87

Voice Mail Transfer with ID Digits	88
Voice Mailbox Button	88
Voice Mail Group Button	88
Voice Mail Group Access	89
Voice Mail One-Touch Recording	89
Voice Mail (Flash-Based) Quick Reference	91
Voice Mail (Flash-Based) Quick Start	92
Voice Mail (Hard Drive-Based) Quick Reference	93
Voice Mail (Hard Drive-Based) Quick Start	94
Volume Control	95
Worksheets	97
Default Numbering Plan	98

» » » » » » » » **NOTES** » » » » » » » »



Digital Keypad - Features & Buttons

24-Button Executive Telephone

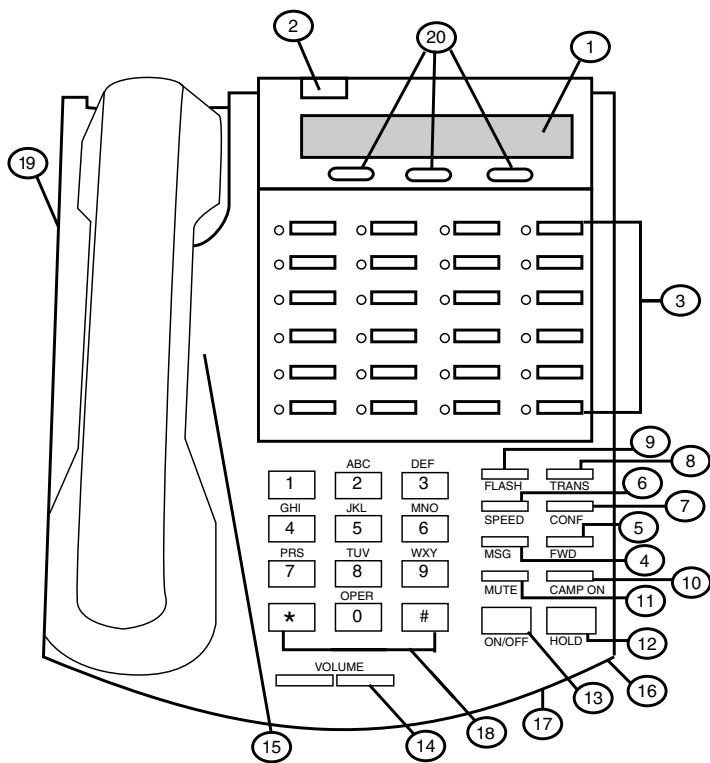

NUMBER	FEATURE	DESCRIPTION
1	LCD Display	Shows information about telephone status, dialing directories, and text messages.
2	Message Indicator	Programmable indication for Ring Line, Voice Mail, Message Wait, or handset operation.
3	Flexible Buttons	To access outside lines and handling calls.
4	MSG Button	For Auto-CallBack to a phone that left a text message or to access voice messages.
5	FWD Button	To forward your calls to another station or voice mail.
6	SPEED Button	To access speed dialing, save number redial, and last number redial. Button is also used to access flexible button programming.
7	CONF Button	To establish conference calls.
8	TRANS Button	To transfer an outside call from one station to another.
9	FLASH Button	To end an outside call and to restore dial tone without hanging up receiver.
10	CAMP ON Button	To alert a busy station that an outside line is on hold and waiting for them.
11	MUTE Button	To activate/deactivate MUTE function. When pressed, party on other end cannot hear you.
12	HOLD Button	To hold calls or to retrieve held calls.
13	ON/OFF Button	To make a call without lifting the handset.
14	VOLUME Button	To adjust level of tones, background music, ringing, receiver volume, and display contrast.
15	Speaker	Outputs tones and voice at your extension.
16	Microphone	To talk with other party without using the handset.
17	H P T Switch	To select mode of operation: Handsfree, Privacy, or Tone.
18	Dial Pad Keys	To place internal & external calls, and to enter programming & feature codes. <i>KEYS: 0-9, *, #</i>
19	Headset Jack	2.5 mm Headset Jack is located on the left side of the telephone.
20	Interactive Soft Keys	To work in conjunction with fixed and flexible features.

» » » » » » » » **NOTES** » » » » » » » »



ABOUT THIS USER GUIDE

The features described in this User Guide apply to the VODAVI *STS* Digital and Single Line Telephone Systems.

GUIDELINES

Flexible Buttons -- Most system features can be set up on a flexible button for easy one-button access. (For more details, refer to *"Flexible Button Programming" on page 47*)

This "Flex Btn" symbol indicates those features that need a *preprogrammed* button to function properly.



- EXCEPTION -

When the "Soft Key" symbol is also present, using a *preprogrammed* button OR a Soft Key is permitted.



Flexible Numbering -- This feature will allow you to modify the system numbering plan, as well as, the length of the feature access codes (2-4 digits).

For consistency, the following programming and operating procedures refer to "3-digit" default codes.

To verify the numbering plan for your system, consult with your System Administrator.

Single Line Telephones -- A "telephone" symbol appears when the Single Line Telephone (SLT) operation differs from a Digital Telephone.



If your single line telephone does not have a FLASH key, quickly press and release the hookswitch when instructed to press the FLASH key.

911 Alert



Any station user or Attendant who programs a flexible button for 911 ALERT (feature code 608) will be alerted of internal stations placing 911 calls. The system can store the 16 most recent 911 calls. Calling information includes the time/date of the call and the station number from which the call was placed.

Initial 911 Alert indications include the following:

- » Audible ringing tone
- » Green flashing 911 ALERT flexible button LED
- » Automatic LCD display of 911 call information

E911 CALL	XX:	STA XXXX
MM/DD/YY		HH:MM

XX = Index number (01-16)

Station users and Attendants can press the flexible button as necessary to view additional 911 call information in the stored list. Once a station user or Attendant views the information for all 911 calls in the system list:

- » LEDs at all stations will change to a solid red indication.
- » Audible ringing tone at all stations ceases.
- » LCDs at all stations will revert to a normal display.

The list remains available for review by pressing the 911 ALERT flexible button until all messages are deleted.

To delete logged 911 Alert messages:

An Attendant must use the following steps to delete the messages on a system-wide basis.

1. Press the 911 ALERT flexible button to display the 911 call information for deletion.
2. Press FLASH to delete that message.

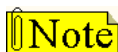

Dialing 911 from any station overrides previously enabled features such as Do Not Disturb.

Account Codes

You can enter an account code that contains up to 12 digits. If fewer than 12 digits are entered, you will need to press the [*] key to return to the call.

Using Account Codes



Prior to placing, or during, an outside line call:

1. Press the *preprogrammed* ACCOUNT CODE button (627).
2. Dial the account code. (The other party does not hear the digits being dialed).
 - » If account codes are forced, the account code must be entered prior to dialing the outside number.
3. Dial [9] or CO Access code. A dial tone will sound.
4. Dial the desired number.

Verified Account Codes



Prior to placing an outside line call:

1. Press the *preprogrammed* ACCOUNT CODE button (627).
2. Dial the account code.



SINGLE LINE TELEPHONE

To enter an Account Code before a call:

1. Lift the handset and dial [627].
2. Dial the account code.
3. Dial [9] or the CO Access code. A dial tone will sound.
4. Dial the desired number.

To enter an Account Code during a call:

1. Press the FLASH button. Call is placed on executive hold while you enter your account code.
2. Dial [627], then dial the account code.

Account Codes - Traveling COS (Verified)



To use Verified Account Codes:

1. Press the *preprogrammed* ACCOUNT CODE button (627) before accessing a CO line.
2. Dial the account code. If the account code matches a verified account code, an intercom dial tone is returned. Otherwise an error tone is presented.
3. Access an outside CO line, or dial the LCR code, then dial the desired number.

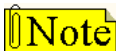

SMDR must be enabled for the Account Code feature to operate, and become part of the SMDR record.



SINGLE LINE TELEPHONE

To enter an Account Code before a call:

1. Lift the handset and dial [627].
2. Dial the account code (*up to 12 digits*).
(If less than 12 digits, press [*] to return to intercom dial tone.)
3. Dial [9] or the CO Access code. A dial tone will sound.
4. Dial the desired number.

Answering Machine Emulation



When a call is sent to your voice mailbox, you can press a *preprogrammed* flexible button to listen to the caller leaving the voice mail message. If you decide to speak with the caller, you can press the *preprogrammed* button to be connected to the caller.

Notification Methods

There are two methods of notification, a Ring Mode or a Speaker Mode. These methods are controlled by the type of flexible button assigned on the telephone. The *preprogrammed* button type (654+0=Ring Mode, 654+1=Spkr Mode) defines the operation mode. An incoming CO call rings at a station and forwards (except busy type) to station's VM mailbox.

Ring Mode

The *preprogrammed* flexible button flashes red while the caller is in your mailbox. You can press the flashing button and the audio is broadcast over the speaker of the keyset. The MUTE key is also enabled and the LED lights solid green. When the call is ringing the station in the ring mode, the display shows:

```
SCREENING RING
MMM DD YY    HH:MM am
```

Speaker Mode

The VM message is broadcast over the speaker. The MUTE key is enabled and the LED lights solid green. When the station is monitoring the caller in VM, the display shows.

```
SCREENING
MMM DD YY    HH:MM am
```

Mailbox Options

The Mailbox Owner can select from the following options when a call is sent to their voice mailbox.

To leave caller in VM and turn off speaker:

Press the ON/OFF button and continue to listen to message being left without taking action at the keyset.

After the VM message is left, the *preprogrammed* button will be solid red and the keyset will return to idle.

To talk to party leaving the message:

Press the MUTE key. The station is still in CONF and the caller can hear VM and you.

To pick up call:

Press the flexible button. When the call is picked up, the voice mail system will disconnect from the call.

Attendant Features

If your station is designated as the Attendant station, the following features are available to assist you in operating your telephone.

Attendant Clear Alarm

The Attendant can dial feature code [606] to clear any T-1 alarm. This function does not clear the condition, only the display (not applicable to **STS** Home systems).

Attendant CO Line External (Off-Net) Forward

To activate off-net forwarding:

1. Dial [603] on the dial pad, or press the *preprogrammed* CO OFF-NET FORWARD button.
2. Dial the CO group access code of group to be forwarded:
[801-823] = CO Group 1-23
[824] = All CO Groups
3. Dial the speed bin number that contains the number where calls are to forward. A confirmation tone will sound.

To cancel off-net forwarding:

1. Dial [603] on the dial pad, or press the *preprogrammed* CO OFF-NET FORWARD button.
2. Dial the CO group access code.
3. Dial [#] on the dial pad. A confirmation tone will sound.

Attendant Custom Message

Program the ten custom messages for system-wide use at the first Attendant station as follows:

1. Dial the Custom Message program code [694] on the dial pad. The following message displays:

ENTER MSG NO MMM DD YY HH:MM am

2. Enter a valid message bin number [21–30]. The following message displays after the bin number has been selected.

m m m m m m m m m m ... ENTER MSG:

3. Enter the letters for the custom message using the dial pad keys as shown:

			Other Codes			
1	A - 21 B - 22 C - 23	D - 31 E - 32 F - 33	1 = 1#	8 = 8#	" = 01	* = *#
G - 41 H - 42 I - 43	J - 51 K - 52 L - 53	M - 61 N - 62 O - 63	2 = 2#	9 = 9#	, = 02	(= #1
P - 71 R - 72 S - 73 Q - 74	T - 81 U - 82 V - 83	W - 91 X - 92 Y - 93 Z - 94	3 = 3#	0 = 0#	? = 03) = #2
*	OPER 0	#	4 = 4#	Space = 11	/ = 04	+ = #3
			5 = 5#	: = 12	! = *1	== #4
			6 = 6#	- = 13	\$ = *2	# = ##
			7 = 7#	' = 14	& = *4	. = 24

- Up to 24 alphanumeric characters may be used (represents 48 digits). Characters display when entered.
 - An Attendant must go idle after programming a message before another message may be programmed.
4. Press HOLD to enter message; confirmation tone will sound.

Attendant Day/Night/Special



OR



The system's Automatic Night Mode Feature can be overridden by the Attendant station. Any Attendant station user can press their DND button or a Soft Key to place the system into Night Mode.

Note

The Night Service feature provides a means to put the system in night mode or remove the system from night mode from any keyset, providing the system was put in night mode by the night service feature flexible button [604].

If the system was placed in night mode by the Attendant using the DND button or if the system was placed in night mode by the automatic schedule, the Night Service flexible button cannot remove the system from night mode.

To use the Attendant Day/Night/Special feature:

1. Press the *preprogrammed* NIGHT SERVICE button (631, DND by default) once to activate the Night mode or use the Soft Key's DND option when in an idle condition (LED is lit solid).
2. Press the DND button or Soft Key again to activate the Special mode (LED flashes).
 - The DND button (by default) or Soft Key acts as a rotary in this manner, starting in the Day mode, Night mode, and Special mode.
 - When one Attendant activates this mode, other Attendant stations' DND buttons are lit accordingly.

Attendant Directory List Programming

The Attendant can program up to 200 names in the directory list. When the directory list is accessed by any display telephone user, the system displays the name associated with a speed dial number so when the desired name is shown, the user may then have the system dial the number.

To access Directory List Programming:

Dial the Directory List program code [693].

The HOLD button will illuminate and the first entry (000) in the Directory List will display:

DIR LST AAA BIN/ICM: XXXX nnnnnnnnnnnnnnnnnnnnnnnnnnnnnnnn

AAA = Directory List entry number (000-199)

XXXX = One of the following:

» 3- or 4-digit station number (100-8999)

» 3-digit local number/name translation table number (600-799 minus station numbers that would overlap)

» 4-digit system speed bin number (9020-9099)

nnn = Programmed Name (blank, if none)

Directory List

The following procedure is used to enter, edit, and erase names in the Directory List for stations or speed dial numbers.

To modify the Directory List:

- Enter desired three-digit Directory List number (000-199),
-or-
Scroll through the Directory List using [*] to view the next entry, and [#] to view the previous entry.
» If changing a name that is already associated with an existing station, skip to Step 4.
- Press TRANS, then dial 3- or 4-digit station intercom number.
- Press MUTE.
- Enter the name (up to 24 characters) using the dial pad keys. The display updates as the name is entered.

			Other Codes			
1	A - 21 B - 22 C - 23	D - 31 E - 32 F - 33	1 = 1#	8 = 8#	" = 01	* = *#
	G - 41 H - 42 I - 43	J - 51 K - 52 L - 53	2 = 2#	9 = 9#	, = 02	(= #1
	P - 71 R - 72 S - 73 Q - 74	T - 81 U - 82 V - 83	3 = 3#	0 = 0#	? = 03) = #2
		M - 61 N - 62 O - 63	4 = 4#	Space = 11	/ = 04	+ = #3
			5 = 5#	: = 12	! = *1	= = #4
			6 = 6#	- = 13	\$ = *2	# = ##
			7 = 7#	' = 14	& = *4	. = 24
*	OPER 0	#				

- Press SPEED when finished. A confirmation tone sounds and the display shows the new or changed name.
- Press HOLD, then use the [*] or [#] key to view other entries.
-or-
Hang up to end programming.

To clear an entry:

1. Select the desired entry.
2. Press TRANS, then press FLASH.
3. Press SPEED, a confirmation tone sounds and entry is erased.

Local Translation Table

The following procedure is used to associate names to the Local Number/Name Translation Table number only.

To add names to Local Translation number:

1. Enter desired three-digit Directory List number (000-199),
-or-
Scroll through the Directory List using [*] to view the next entry, and [#] to view the previous entry.
» If changing a name that is already associated with an existing Table entry, skip to Step 4.
2. Press TRANS.
3. Dial the three-digit Local Number/Name Translation Table number (600-799) that represents the telephone number.
4. Press MUTE.
5. Use the dial pad keys to enter the name (up to 24 characters). The display updates as the name is entered.

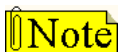

If an error is made during keystroke entry, press FLASH to clear the current name.

6. Press SPEED when finished. A confirmation tone sounds and the display shows the new or changed name.
7. Press HOLD, then use the [*] or [#] key to view other entries.
-or-
Hang up to end programming.

Speed Dial Bin

The following procedure is used to associate names to a system speed dial bin only.

To add names to a System Speed Bin:

1. Enter desired three-digit Directory List number (000-199),
-or-
Scroll through the Directory List using [*] to view the next entry, and [#] to view the previous entry.
(If changing a name that is already associated with an existing System Speed Dial Bin entry, skip to Step 4.)
2. Press TRANS.
3. Dial the system speed dial bin location (9020-9099).
4. Press MUTE.
5. Use the dial pad keys to enter the name (up to 24 characters). The display updates as the name is entered.
6. Press SPEED when finished. A confirmation tone sounds and the display updates.
7. Press HOLD, then use the [*] or [#] key to view other entries.
-or-
Hang up to end programming.

Attendant Disable Outgoing CO Line

The first Attendant can disable CO lines to prevent outgoing access to those lines.

To disable a CO Line:

1. Lift the handset, or press the ON/OFF button.
2. Dial [602] on the dial pad. A confirmation tone will sound.
3. Press the line button of the CO Line to disable. The CO Line button LED flashes; a confirmation tone sounds.

To reactivate the CO Line(s):

Repeat Steps 1-3 to disable this feature.

Attendant Override



When Attendant Override is enabled, Attendant stations may override or call stations that are busy or in Do Not Disturb.

To call a station busy on a CO call:

Press the *preprogrammed* ATTN OVERRIDE button [601].
Three short tone bursts are presented to the called party.

After five seconds, the station's CO line is automatically placed on hold and the Attendant is cut-through.

To call a station in Do Not Disturb mode:

Press the *preprogrammed* ATTN OVERRIDE button. The station is signaled with a Camp On tone.

Attendant Setting Time and Date

System Time/Date must be set by the first programmed Attendant via admin programming or using feature code 692.

To set using the feature code:

1. Dial [692] on the dial pad. A confirmation tone will sound.
2. Enter date and time as follows: YYMMDDHHMM
YY = Year (00-99) HH = Hour (00-23)
MM = Month (01-12) MM = Minute (00-59)
DD = Day (01-31)

When the correct number of digits are entered, a confirmation tone will sound.

3. Press the ON/OFF button to OFF to update the display.

Attendant Speed Dial - System Storing

System Speed numbers must be entered by the first programmed Attendant. If an Attendant is not specified, enter at Station 100.

1. Press SPEED, then press the desired outside line key,
-or-
Press SPEED + SPEED to select an outside line automatically.
2. Dial the System Speed bin location (*9020-9099*).
3. Dial telephone number, press SPEED, then hang up.

Speed Dial Options

To use the following speed dial options, enter as shown:

Initiate a Pulse-To-Tone Switchover	Press TRANS during number entry.
Insert a Pause	Press HOLD during number entry.
Insert a Flash into Speed Number	Press FLASH.
Insert a Non-Display Character	Press TRANS as first entry in speed bin. This causes the numbers stored in the bin not to display on the Digital Telephones when the bin is accessed.

NOTE ... Speed Bin numbers 9060-9099 are not monitored by Toll Restriction.

Attendant Unavailable

The Attendant Unavailable feature lets Attendant stations have a button that places their station in an Unavailable Mode. When the station is in the Unavailable Mode, the next Attendant station receives dial “0” calls and recalls.

To activate Unavailable Mode:

As the (first programmed) Attendant ...

Press the *preprogrammed* UNAVAILABLE flexible button,
-or-

Dial the Attendant Unavailable code [607] on the dial pad,
and the following results occur:

- The flexible button LED lights solid, if programmed.
- Recalls and dial “0” calls ring at 2nd Attendant’s station.
- If the 2nd Attendant places their phone in unavailable, the 3rd Attendant will receive recalls and dial “0” calls, and so forth through the sixth Attendant.

To deactivate Unavailable Mode:

As the (first programmed) Attendant ...

Repeat activation process shown above (press Unavailable button or dial code 607), the following results will occur:

- The flexible button LED, if programmed, will extinguish.
- The first Attendant will resume normal operation.
- The second through sixth Attendants will not receive recalls or dial “0” calls.

Attendant Voice Mail Alarm Clear

The Attendant display shows an alarm condition when the system detects that the digital voice mail is out of service.

Dial feature code [656] to clear any alarm from the display.
This function does not clear the condition, only the display.

Background Music (Optional)



To activate Background Music, either:

1. Dial [632] or press the *preprogrammed* BGM flexible button, then enter [1] on the keypad.

-or-

Use the Soft Key's BGM option as a toggle.

0:OFF	1: CH-1
MMM DD YY	HH:MM am

A confirmation tone will sound, and the music is audible through the speaker.

2. Press Volume Bar to change the volume. The LCD displays:

SPEAKER BGM [#####]
MMM DD YY HH:MM am

To deactivate Background Music:

1. Dial [632] again or press BGM flexible button, then enter [0].

-or-

Use the Soft Key's BGM option as a toggle.

2. A confirmation tone will sound; the music will discontinue.



SINGLE LINE TELEPHONE

The Background Music feature is not compatible with Single Line Telephones.

Call Back



A station can initiate a call back request to another busy station. Once that station becomes idle, the station that left the call back request is signaled.

To leave a Call Back request when a number is busy:

1. Press the *preprogrammed* CALL BACK flexible button or use the Soft Key's CALL-BK option.
2. Replace the handset, or press the ON/OFF button. When the busy station hangs up, you will be signaled.
3. Answer the call; the station you called will then be signaled. (If your station is busy when signaled, an automatic MSG will be placed at your phone.) Only one Call Back request can be left at a station; the second request will leave a message wait callback request.



When the Automatic Call Back Timer is enabled, a call back request is automatically invoked anytime you listen to a busy intercom tone for a preset period of time (default = 10 seconds).



SINGLE LINE TELEPHONE

To leave a Call Back request when a number is busy:

1. Press the FLASH button.
2. Dial [622], then replace the handset.

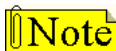

Only one Call Back request can be left at a station; the second request will convert to a message waiting request.

Call Coverage



The Call Coverage feature provides the functionality for stations to answer calls for other stations by utilizing call coverage buttons. Visual and Audible status of ringing stations to an assigned coverage station are provided.

To assign a Call Coverage Button:

1. Press SPEED + SPEED.
2. Then press the desired flexible button.
3. Dial [647] for *Non-Ringing* or [646] for *Ringing*, followed by the station number to cover. A confirmation tone will sound.

After button is assigned, and that station receives a call:

1. After a programmable period of time, you will receive an audible and/or visual indications: an internal ring tone, and/or the same flash rate as the incoming CO line ringing rate.

RINGING Option = ringing, flashing Call Coverage LED, LCD display as in following illustration:

CALL FOR STA XXXX MMM DD YY HH:MM am
--

NON-RINGING Option = flashing Call Coverage LED only (no ringing or change to LCD)

2. Then press the flashing COVERAGE flexible button, or press the ON/OFF button.

The call is answered and will cease to ring at any other stations that may have the same coverage appearance. The following message displays after the call is answered.

CALL FOR STA XXXX
FROM STA YYYY HH:MM am



SINGLE LINE TELEPHONE

This feature can cover SLT extensions, however an SLT cannot perform the call coverage function. The SLT extension need not be physically installed, but the SLT card must be installed.

Call Forward



The Call Forward feature allows a station the ability to have calls (internal or external) forwarded to a designated station, a UCD group pilot number, Voice Mail group number, or Hunt group. This feature must be enabled in admin programming.

To activate Call Forwarding:

1. Lift the handset, or press the ON/OFF button.
2. Press the FWD button or dial [640], then dial the appropriate forwarding condition code.

[6] = All Calls

[8] = Busy

[7] = No Answer

[9] = Busy/No Answer

-or-

Use the applicable Soft Key's ALL-FWD, N/A-FWD, BSY-FWD, or B/NA-FWD option.

3. Press the DSS button of the desired station,

-or-

Dial the desired extension number where to forward calls, including UCD, Voice Mail, Hunt Group pilot numbers and Speed Dial bins for off-net forwarding.

4. Replace the handset, or press the ON/OFF button.

To remove Call Forwarding:

1. Lift the handset, or press the ON/OFF button.
2. Either press the FWD button, dial [640] or [662], or use the Soft Key's CLR-FWD option. A confirmation tone sounds and the FWD LED extinguishes.

**SINGLE LINE TELEPHONE**

The SLT operation uses the same procedures as the Digital Telephone, except there is no FWD button or Soft Keys. You must use feature codes 640 and 662.

Call Forward - External (Off-Net)

Stations are allowed to forward intercom and transferred CO line calls to an off-net location. The Call Forward Off-Net feature allows a station to reroute calls that would normally be lost. Calls can be forwarded to home or another off-net site. Initially ringing CO calls cannot be forwarded with this feature.

To activate Off-Net Call Forwarding:

1. Lift the handset, or press the ON/OFF button.
2. Press the FWD button, or dial [640].
3. Dial [*] on the dial pad, then enter the speed bin number (9000-9019 or 9020-9099) that contains the number where calls are to be forwarded. A confirmation tone will sound, and the FWD button LED is flashing.
4. Replace the handset, or press the ON/OFF button.

To remove Off-Net Call Forwarding:

1. Lift the handset, or press the ON/OFF button.
2. Press the FWD button or dial either [640] or [662]. A confirmation tone sounds and the FWD LED extinguishes.



SINGLE LINE TELEPHONE

The SLT operation uses the same procedures as the Digital Telephone, except there is no FWD button. The user must enter the 640 feature code to activate and 662 to clear.

Call Forward - Follow Me

The Follow Me feature allows a user who is away from their station, to activate/deactivate call forwarding from another station in the system. This lets the user forward their calls to their current location or into Voice Mail, UCD, Hunt Groups, any other station in the system, or to an off-net location. When this call forward is activated, all calls presented to the forwarded station will immediately forward to the destination station.

To activate Follow Me Call Forwarding:

1. Lift the handset, or press the ON/OFF button.
2. Dial the Follow Me Forward code [642] on the dial pad.
3. Dial the station number where forwarding is desired.
4. Dial the appropriate forwarding condition code.
[6] = All Calls [8] = Busy [*] = Off-Net
[7] = No Answer [9] = Busy/No Answer
5. Dial the three- or four-digit destination number where calls are to be forwarded. (Station, Voice Mail, UCD, Hunt Group, or speed bin (only for off-net)).
6. Replace the handset, or press the ON/OFF button.

To remove Follow Me Call Forwarding:

1. Lift the handset, or press the ON/OFF button.
2. Dial the Follow Me Forward code [642] on the dial pad.
3. Dial the station number where forwarding is to be cancelled.
4. Dial [6], *regardless of the forward condition*.
5. Redial the same station number. A confirmation tone sounds and FWD LED extinguishes.

To establish Follow Me Call Forwarding (off-site location):

1. Dial into the system on a DISA or TIE trunk. Enter the DISA access code, if applicable.
2. Dial the Follow Me Forward code [642] on the dial pad.
3. Dial the station number where forwarding is desired.
4. Dial the appropriate forwarding condition code.
[6] = All Calls [8] = Busy [*] = Off-Net
[7] = No Answer [9] = Busy/No Answer
5. Dial the three- or four-digit destination number where calls are to be forwarded (System Speed Bin (off-net only), Station, Voice Mail, UCD, or Hunt Groups). A confirmation tone sounds; five seconds later a dial tone is received.

To remove Follow Me Call Forwarding (off-site location):

1. Dial into the system on a DISA or TIE trunk. Enter the DISA access code, if applicable.
2. Dial the Follow Me Forward code [642] on the dial pad.
3. Dial the station number where forwarding is to be cancelled.
4. Dial [6], *regardless of the forward condition*.
5. Redial the same station number. A confirmation tone sounds; five seconds later a dial tone is heard.

Call Park

Call Park - Personal

Each digital telephone in the system can place a call into a personal park location and then later retrieve that call from the originating station. Internal calls and external calls can be placed into the stations' personal park location. Calls parked in a personal park location are subject to the system call park recall timer.

To park a call:

1. Press TRANS, the caller is put on Exclusive Hold.
2. Dial the Personal Park location code [438] on the dial pad,
-or-

Press the *preprogrammed* PERSONAL PARK button. A dial tone will sound.

To retrieve a parked call:

Dial Personal Call Park location code [438] on the dial pad,
-or-

Press the *preprogrammed* PERSONAL PARK button. A talk path will be established between the two parties.



SINGLE LINE TELEPHONE

To park a call:

1. Press FLASH, a dial tone will sound.
2. Dial [438]. The call is placed in personal park.

To retrieve a parked call:

Dial [438]. The call is returned.

Conditions

- » If the Call Park user receives or makes a second call while the first call is parked, the user can alternately connect to the two calls by pressing the *preprogrammed* PERSONAL PARK button or by dialing [438].

Call Park - Station

Call park (by station number) allows external calls to be parked at a station other than your own.

To park a call:

1. Press TRANS, the call is put on Exclusive Hold.
2. Dial [439], then dial the station number.

-or-

1. Press TRANS, the call is put on Exclusive Hold.
2. Press the *preprogrammed* CALL PARK (Station) button, then dial the station number.

To retrieve a parked call:

Dial [# 6] + [the station number used to park the call] from any telephone in the system, including the initiator's.

-or-

Dial [438] from the initiator's station.

To create a CALL PARK (Station) button:

1. Press SPEED + SPEED.
2. Press the desired flexible button.
3. Dial [439] + [#]. A confirmation tone will sound.



SINGLE LINE TELEPHONE

The SLT user cannot park a call using the Call Park - Station feature, but can retrieve a Call Park - Station call by using the [#6] procedure as shown in the digital keyset section above.

Call Park - System

An external call can be placed into one of eight parking locations, and can be retrieved by any station that has a direct line appearance or an available Loop button. Parked calls have their own recall timer that recalls the originating station, and if still unanswered, an Attendant.

To park a call:

1. Press TRANS, the caller will be put on hold.
2. Dial parking location (430-437). A confirmation tone will sound.
3. If a busy tone is received, press TRANS + TRANS and dial another park location, or press the CALL PARK flexible button for a different parking location.

-or-

1. Press the CALL PARK flexible button. The caller will be parked at the location programmed on the button.
2. If a busy tone is received, press TRANS + TRANS and dial another park location, or press the CALL PARK flexible button for a different parking location.

To retrieve a parked call:

1. Lift the handset or press the ON/OFF button, then press [#].
2. Dial parking location (430-437) where call was parked, or press *preprogrammed* PARKED CALL PICKUP flexible button.

-or-

Use the Soft Key's P-PKP 1 option when in an idle condition (to pickup from park location 1 only).

To create a PARKED CALL PICKUP button:

1. Press SPEED + SPEED, then press the desired flexible button.
2. Dial [#] + the desired parking location (430-437).



SINGLE LINE TELEPHONE

To park a call:

1. Press FLASH, the caller is put on Exclusive Hold.
2. Dial parking location (430-437); confirmation will sound.
3. If busy, press FLASH + FLASH and dial another park location.

To retrieve a parked call:

1. Lift the handset and press the [#] button.
2. Dial parking location (430-437) where call was parked.

Call Pickup

A station can pickup a call ringing to any specific unattended station by using the Directed Call Pickup procedure.

A station can pickup a call ringing to an unattended station within the same UCD group by using the Group Call Pickup Procedure.

Directed Call Pickup



To create a Pickup Button:

1. Press SPEED + SPEED.
2. Press the desired flexible button, then dial #0.

To use Directed Call Pickup:

1. Dial the station number of the known ringing telephone. Receive ringback tone or call announce tone depending on the intercom selector switch setting.
2. Press the *preprogrammed* PICKUP button to answer the call.



SINGLE LINE TELEPHONE

To use Directed Call Pickup:

1. Lift the handset and dial [#1].
2. Dial the station number of the ringing telephone.

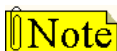

You MUST have access to the specific outside line or a LOOP button to do a directed call pickup.

Group Call Pickup

To create a Pickup Button:

1. Press SPEED + SPEED.
2. Press the desired flexible button, then dial #0.

To use Group Call Pickup:

1. Lift the handset, or press the ON/OFF button.
2. Dial [#0] on the dial pad, or press a *preprogrammed* PICKUP button to connect to the calling party.



SINGLE LINE TELEPHONE

To use Group Call Pickup:

Lift the handset and dial [#0]. You will be connected to the incoming intercom or outside line call.

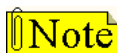

You must be in the same Pickup group as the ringing telephone to pickup the call.
You MUST have access to the specific outside line or LOOP button to use Group Call Pickup.

Call Transfer

An outside line can be transferred from one phone to another within the system. The transfer can be screened (announced) or unscreened to an idle or busy station, or to a UCD or Hunt Group. Outside line calls can also be transferred to another outside destination by using a trunk-to-trunk transfer.

Executive/Secretary Transfer

- If you are the designated Executive station, and your phone is busy or in DND, all calls will be routed to the Secretary station.
- If you are the designated Secretary station, you can signal the Executive that is busy or in DND by using the Camp On feature.

PBX/Centrex Transfer

While connected to an outside line (PBX/Centrex):

1. Press FLASH, the transfer dial tone will be heard.
2. Dial the PBX/Centrex station number, then hang up to complete the transfer.



SINGLE LINE TELEPHONE

To make a PBX/Centrex Transfer:

1. Press the FLASH button. An intercom dial tone will sound.
2. Dial [660]. A Flash command is presented to the PBX or Centrex CO Line (a stutter tone will sound).
3. Dial the desired telephone number, then replace the handset to complete the transfer.

Screened Transfer

To conduct the transfer, while connected to an outside line:

1. Press the station button where the call is to be transferred (if programmed on your telephone), or press TRANS and dial the station number. The called extension signals according to the intercom signal switch position.
2. When that extension answers, announce the transfer.
3. Hang up to complete the transfer.

To answer the Screened Transfer:

Your intercom will be signaling according to the intercom signal switch position.

1. Answer the intercom and receive the transfer notice.
2. Press the OUTSIDE LINE, or the flashing LOOP button on hold.

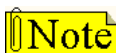

If the Direct Transfer feature is enabled, the screened transfer will go directly to the handset. You do not have to press a LINE or LOOP button to answer.

Transfer Search

When attempting to locate a party:

1. Press a station DSS button to signal the station,
-or-
Press TRANS and dial the desired station.
2. If the station is unavailable, press another station DSS button to enter a new station number
-or-
Press TRANS + TRANS and dial the station number.
3. When the station answers, hang up to complete transfer.

Unanswered CO Call Transfer

While idle or on an internal/external call and an incoming or transferred CO call is ringing at your station:

1. If on another call, place the current call on hold, and replace the handset or press the ON/OFF button.
2. Dial the INC CO XSFR code [639], or press the *preprogrammed* INC CO XSFR flexible button.
3. Press a DSS, Group button, or dial a station or group number. The call automatically transfers to that destination.
4. You can then return to the call placed on hold.

Unscreened Transfer

1. Press TRANS.
2. When the called extension begins to signal, hang up to transfer the call (the Recall Timer start).
3. Replace the handset, or press the ON/OFF button.

Trunk-To-Trunk Transfer

While connected to an outside line (PBX/Centrex):

1. Press TRANS. The transfer dial tone sounds.
2. Press a CO line / Loop flexible button.
-or-
Dial [9].
-or-
Dial a CO line/group access code.
3. Dial the desired outside line destination number.
4. Hang up to complete the transfer.

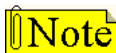

*E911 feature enabled precludes dial 9 access.
LCR feature enabled precludes Loop button access.*



SINGLE LINE TELEPHONE

While connected to an outside line (PBX/Centrex):

1. Press the FLASH button. A dial tone will sound.
2. Dial [9].
-or-
Dial a CO line/group access code.
3. Dial the desired outside line destination number.
4. Hang up to complete the transfer.

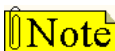

E911 feature enabled precludes dial 9 access.

Caller ID Display

Caller ID Display (Answered Calls)

The Answered Caller ID Table feature can store up to 100 system-wide entries of the most recently answered calls with caller ID. A station may dial a unique access code to view the entries, scroll through the entries, and dial a desired entry back. The table displays the caller ID number and the identity of the station that answered the call.

This table may be accessed from any user station display phone. Any Attendant station can delete a table entry, one entry at a time.

To start the review process at the beginning of the table:

Dial [659].

Caller ID Display (Unanswered Calls)

An Unanswered Call Management Table with 100 system-wide entry capacity is maintained in the system. The calling number/name information pertaining to any unanswered call is placed in this table when the system determines the call was abandoned.

This table may be accessed from any display telephone to review unanswered calls. Only an Attendant station(s) can delete an entry from this table.

To start the review process at the beginning of the table:

Dial [635].

Keypad Functions

The following functions apply to both Answered and Unanswered Call Management Tables:

Function	Button
Review next item in table entry	MUTE
Step to next table entry	HOLD
Delete table entry (Attendant only)	FLASH
Exit table review function	ON/OFF
Step to previous table entry	TRANSFER
Call Back	SPEED

Caller ID Name/Number



This feature allows you to program a flexible button [653] to view both the number and name on the LCD when receiving a Caller ID CO call. When the feature is enabled, the flexible button LED is lit solid and the name and number is displayed.

During the call:

Press the flexible button to toggle between the normal call information display and the name/number display.

The top line of the LCD displays the number of the caller and the bottom line of the LCD displays the name.

Calling Forward Override

The Call Forward Override feature allows a user to reach a busy station that is call forwarded. This allows the calling station to override the forwarding which allows the user to use Off Hook Voice Over (OHVO), Executive Override, Monitor, Message Wait Indication, Camp On, or Call Back Request at that station rather than forwarding to another destination.

To reach a busy station that is call forwarded:

1. Dial [5#] followed by the desired station extension.
2. Press the appropriate *preprogrammed* button.

Call Back = [622]

Camp On = [620]

Executive Override = [625]

Message Wait = [623]

OHVO = [628]

Calling Station Handsfree Mode Override

This feature enables a calling station to override a called station's T intercom setting.

When placing a call to a station and handsfree is desired:

1. Dial [7#] on the dial pad.
2. Dial the extension number,
-or-

Press the DSS button of the desired station (the call connects to the station in a handsfree mode).

Calling Station Tone Mode Override

This feature enables a calling station to override a called station's H or P intercom settings.

When placing a call to a station and tone ringing is desired:

1. Dial [6#] on the dial pad.
2. Dial the extension number,
-or-

Press the DSS button of the desired station (a call tone rings the station).

Camp On

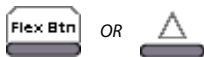

A station may alert a busy party that an outside line is on hold and waiting for them by using the CAMP ON button.

To camp on a call, press the TRANS button to transfer the call to the desired busy station, then press the CAMP ON button.

The busy party will receive a muted ring over the keyset speaker, and a visual flashing CAMP ON LED. By pressing the CAMP ON button, the person called places their existing outside call on hold and is connected to the person placing the Camp On. They can then pick up the call on the appropriate line.

To alert a busy station of your call:

1. Press the CAMP ON button or use the Soft Key's CAMP-ON option. The called station will receive one burst of ringing.
2. When the called party answers, consult with them or hang up to transfer call.

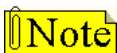

If a station is in DND, only the Attendant can Camp On using the Attendant override feature. Camp On or Override drops any internal callers to which that station is talking.

To answer a call that is waiting:

1. Press your flashing CAMP ON button when you hear one burst of muted ringing. Any outside line you are connected to will be placed on hold.
2. Converse with the station placing the call,
-or-

If the call is being transferred, press the flashing OUTSIDE LINE button.

**SINGLE LINE TELEPHONE**

To alert a busy station of your call:

1. Press the FLASH button.
2. Dial [620]. When the called line is alerted, they can choose to pick up your call or remain on original call.

To answer a call that is waiting (while on a CO line call):

1. Receive Camp On warning tone through the handset.
2. Choose the desired call (hang up on present call and take new call, or ignore Camp On signal).

CO Line - Access

To access an outside line:

1. Press an idle CO line button or a POOL button,
-or-
Dial a CO line group access code or an LCR code: 9, 801-823, 88+LLL (*LLL = CO Line number*).
2. Dial the desired number for the outside call.
3. Lift the handset to converse, or use the speakerphone.

**SINGLE LINE TELEPHONE**

To access an outside line:

1. Lift the handset.
2. Dial access code: 9, 801-823, 88+LLL (*LLL = CO line number*).
3. Dial telephone number.

CO Line Queue



If you wish to be placed on a waiting list for an outside line to become available:

1. Press the desired busy OUTSIDE LINE button, or press the POOL button. (A busy tone will sound.)
2. Press the *preprogrammed* CO LINE QUEUE button (621).
3. Replace the handset, or press the ON/OFF button.

To answer a queue:

If you hear ringing and an outside line of the line group or a LOOP button you queued onto is rapidly flashing:

1. Lift the handset, or press the ON/OFF button.
2. Press the flashing OUTSIDE LINE button, or LOOP button.

To cancel a call back request:

1. Dial the CO Line Queue Cancel code [626] on the dial pad.
2. Replace the handset, or press the ON/OFF button.



SINGLE LINE TELEPHONE

1. Dial an outside line access code, a busy tone will sound.
2. Press the FLASH button.
3. Dial [621]. A confirmation tone will sound.

Conference

Conference Combinations

Only stations with conference enabled can institute a conference.

ADD-ON Conference -- Up to eight internal parties can engage in a conference, or seven internal parties with one external party. A maximum of five 8-party conferences (five external parties maximum) can be established.

MULTI-LINE Conference -- One internal station can engage in a conference with up to four outside parties.

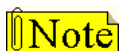

A maximum of eight parties can be included in a conference.

Conference Procedures

To establish a Conference:

1. Lift the handset.
2. Select an intercom station or dial the desired outside party.
3. When called party answers, press the CONF button.
4. Add the next party by selecting another outside line or intercom station, or by using the Soft Key's ADD MEM option.
5. If the next party is an outside line and a busy or wrong number is encountered, press one of the conference parties on hold. This drops the busy or wrong number party. Press the conference button again and repeat step 4.
6. When the last party answers, press CONF + CONF. (All parties will be connected.)

To exit a Conference (controller only):

For a Single-line conference ...

1. Press the ON/OFF button to ON.
2. Press the MUTE button, then replace the handset to monitor the conference.

For a Multi-line conference ...

1. Press HOLD button to place outside parties on hold. The Hold Timer starts. If one of the two parties is internal, that party is dropped.
2. Either ... press CONF and hang up or press ON/OFF button or use the Soft Key's EXIT option to leave the other conference parties still connected in an unsupervised conference.

The CONF button flashes and the timer starts. There is a warning tone before other parties are dropped.

To re-enter a Conference:

When the controller re-enters the conference, the disconnect timer is reset.

1. Lift the handset to re-enter a monitored conference.
2. To re-enter a conference placed on hold, repeat steps for establishing a conference.
3. To re-enter an unsupervised conference, lift the handset and press the flashing CONF button or use the Soft Key's RE-ENTER option. The CONF button will light steady and a confirmation tone will sound.

To terminate a Conference, the conference initiator who is actively in the conference must:

Replace the handset, or press the ON/OFF button to OFF.

To terminate an Unsupervised Conference:

Press the flashing CONF button or use the Soft Key's END option while on-hook, all parties will be dropped.

To terminate a party during a Conference call:

1. Press the line button of the party you wish to drop.
2. Replace the handset, or press the ON/OFF button.
3. Lift the handset, or press the ON/OFF button.
4. Press the flashing CONF button.



SINGLE LINE TELEPHONE

To set up a Conference with one external and one other internal station:

1. Place an outside call.
2. Press the FLASH button to put the call on hold.
3. Dial the number of the internal station you wish to add.
4. When that station answers, press the FLASH button again. All three parties will be connected.

To set up a Conference with Personal Park:

1. While connected to an outside line, press the FLASH button. The intercom dial tone will sound.
2. Dial [438]. The first call will be placed in personal park.
3. Dial the desired number for the second call.
4. Press the FLASH button. The Intercom dial tone will sound.
5. Dial the code for SLT Conference Park [664]. All three parties will be conferenced.
6. Hang up to terminate the conference.

Dial-By-Name

The system allows station users to dial extension numbers, or speed bins, by entering the name of a person that has been programmed for that station.

The system database allows entry of a name (alphanumeric) up to 24 characters in length for each station. The programmed name can be used for dial-by-name station users and in directory dialing.

(NOTE ... This feature should not be confused with the *Name In Display* function.)

1. Dial the Dial-By-Name code [6*] on the dial pad,
-or-
Press *preprogrammed* DIAL-BY-NAME flexible button.
2. Dial the person's last name on the keypad as shown.

Example ...

To search for the name BROWN, press [2] [7] [6] [9] [6].

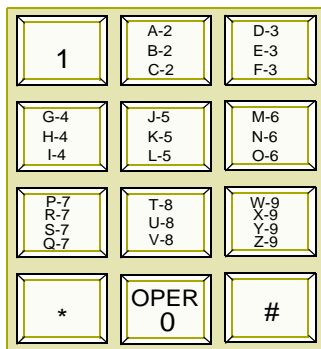

When the system finds a numeric match for the name dialed:

- A call will be placed to the station matching the name.
- An intercom call will signal the station according to the intercom mode selected: H, T, or P.
- If fewer than 8 digits are dialed, the numeric match is dialed after a 10-second interdigit time-out occurs, or when the [#] key is pressed.

Directory Dial



Display telephone users may view a list of up to 200 names from the System Directory on the station's LCD display. You can dial the station or speed dial bin by pressing a single button.

Names placed in the Directory List may be associated to intercom numbers, System Speed dial bins, or entries in the Local Number/Name Translation Table. You may view the Directory List beginning with any letter of the alphabet, then scroll through the list either forward or backwards.

Directory Dialing may also be used to transfer a call from one station to another.

To view the Directory List:

1. Dial the Directory List dial code [680] on the dial pad,
-or-
Press flexible button programmed as directory dialing button,
-or-
Use the Soft Key's DIR-DIAL option when in an idle condition.
2. Press a button on the keypad that represents the letter of the alphabet, to begin viewing the list of names.

For example ... pressing 2 once will produce names starting with A. When 2 is pressed a second time, names that start with B will display. Pressing 2 a third time will display names that start with C.

3. The alphabet is represented on the keypad as shown:

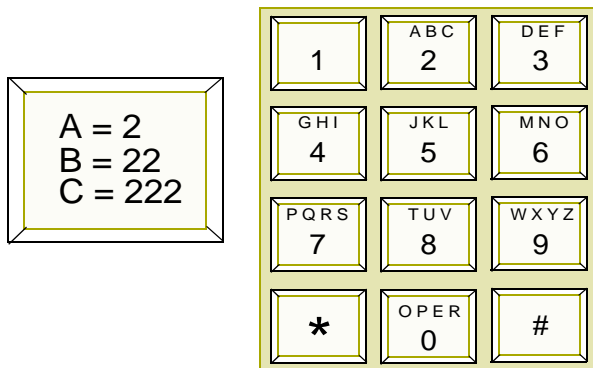

Names starting with the letter chosen will show on the LCD display.

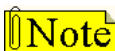

If there are no names in the Directory List beginning with the desired letter, a name with the next higher letter displays on the LCD display.

Letters "Q" and "Z" are not marked on many telephone keypads; however, the illustration above shows the correct keys used to access these letters.

4. Dial [*] to scroll up (next entry) through the list,
-or-
Dial [#] to scroll down (previous entry) through the list,
-or-
Press another key to view the list for a different letter of the alphabet.
5. When the desired name displays on the LCD, press SPEED to automatically dial the destination station or outside phone number (via speed dial).

To transfer a call using Directory Dialing while on a call:

1. Press TRANS.
2. Dial the Directory Dial Code [680] on the dial pad,
-or-
Press the flexible button programmed for directory dialing.
3. Press the digit associated with the person's name. When it displays, press SPEED to automatically dial the destination station.
4. Hang up to complete the transfer.

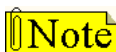

Calls may be transferred to internal stations only. An attempt to transfer a call off-net (via a speed dial bin) results in the call recalling upon going on-hook.



SINGLE LINE TELEPHONE

Not applicable

Do Not Disturb / Page Block



To activate Do Not Disturb:

Press the preprogrammed DND button once (DND button lights steady). The DND button can be pressed while the phone is ringing to stop the ringing.

-or-

Use the Soft Key's DND option when in an idle condition.

To activate Page Blocking:

Press the preprogrammed DND button a second time (DND button flashes).

-or-

Use the Soft Key's DND option a second time when in an idle condition.

To remove Do Not Disturb:

Press the preprogrammed DND button a third time, use the Soft Key's DND option a third time, or dial either [631] or [662]. The button LED extinguishes and DND cancels.

To activate One-time Do Not Disturb:

Press the *preprogrammed* DND button while you are off-hook and connected to a CO line or intercom call. The DND button LED will light, and off-hook tones at your station are cancelled.

To cancel One-time Do Not Disturb:

Replace the handset. The DND button LED will extinguish and DND will be cancelled.



SINGLE LINE TELEPHONE

To activate Do Not Disturb:

1. Lift the handset.
2. Dial [631], then replace the handset.

To remove Do Not Disturb:

1. Lift the handset.
2. Dial [631] or [662], then replace the handset.

Executive Override



Use of this feature when the executive override warning tone is disabled may be a violation of Federal, State or Local Laws, and an invasion of privacy. Check applicable laws in your area before using this feature.

Executive Override allows stations designated as “Executive” the ability to override and “barge in” on other keysets engaged in CO Line conversations. A change in volume may occur on the CO Line or intercom call after the barge-in occurs.

If you call a busy station:

1. Press the *preprogrammed* EXECUTIVE OVERRIDE button (625). The Executive station is bridged onto the CO line conversation in progress at the called station. An optional warning tone is presented to all parties prior to cut-thru.
2. Replace the Executive station handset to terminate override.

Flash

When connected to an outside line:

Press FLASH to disconnect the outside line and reseat an outside line dial tone.

Flash Key on Intercom

When connected to a page zone or another internal party:

Press FLASH to disconnect page or intercom call. An intercom dial tone will sound.

Flexible Button Programming

To program a flexible button (to use feature codes):

1. Press SPEED + SPEED.
2. Press the button to be programmed (must be programmed in database as a flexible button).
3. Dial the desired code. A confirmation tone will sound. (Refer to the ["Default Numbering Plan" on page 98](#), and the feature's description for any additional digits to enter).
4. Press the ON/OFF button.

To program a flexible button (to use speed bin dialing):

1. Press SPEED + SPEED.
2. Press the button to be programmed (must be programmed in database as a flexible button).
3. Press SPEED.
4. Dial the speed bin number. A confirmation tone will sound.
5. Press the ON/OFF button.

To erase a flexible button:

1. Press SPEED + SPEED.
2. Press the flexible button to be erased.
3. Press FLASH, a confirmation tone will sound.
4. Press the ON/OFF button.

To check flexible button programming:

1. Lift the handset.
2. Press SPEED.
3. Dial [7] + [#].
4. Then dial [2] to select the KEYBTN option.
5. Press the desired flexible button(s) to display programming for the button(s) on the LCD.
6. When finished, replace the handset.

Group Listening

All digital key stations have a built-in speakerphone. You can use the speaker to monitor a call while using the handset to consult with the outside party. This enables other people in the room to listen to both parties in the conversation.

To activate Group Listening:

While conversing on the handset, press the ON/OFF button.

Both parties of the conversation can then be heard on the digital station's speaker. The speakerphone microphone is muted while the handset is off-hook.

To deactivate Group Listening:

While off-hook, press the ON/OFF button.



Group Listening is NOT available when the station is in the Headset Mode.

Headset Mode



A modular headset may be used by connecting the headset to the handset jack on the telephone (leaving the handset in place). The ON/OFF button on the Digital Telephone is used to initiate and end calls while using the headset.

To activate Headset Mode:

Dial [634] on the dial pad,

-or-

Press the *preprogrammed* HEADSET MODE button.

-or-

Use the Soft Key's HEADSET option when in an idle condition.

The LED will light steady.

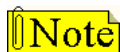

While Headset mode is active, the ON/OFF button activates the headset and disables speakerphone and intercom call announce operation at your station.

To install the headset, see the Installation Manual.

To deactivate Headset Mode:

Dial [634] on the dial pad,

-or-

Press the *preprogrammed* HEADSET MODE button.

-or-

Use the Soft Key's HEADSET option when in an idle condition.

The LED will extinguish.

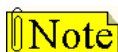

Station must be programmed in database programming for headset operation before the flexible button can be programmed.



SINGLE LINE TELEPHONE

Not applicable

In and Out Button



An In and Out Button will toggle a station from an in status to an out status and from an out status to an in status. When in an out status, the LCD will display "OUT MODE" and all incoming calls will forward to the Preset Internal Busy Forward destination (Flash 50/51, Page C, Button #2). If no forwarding destination is programmed in Flash 50/51, the call will be presented without forwarding. Attendant stations and SLT stations do not have the In and Out feature capability.

To change In and Out status:

Press the preprogrammed In and Out Button (feature code 644).

Intercom

Using an Intercom Button



To program a Flexible Button as an Intercom Button:

1. Press SPEED + SPEED.
2. Press the desired flexible button to program.
3. Dial [645] on the dial pad. A confirmation tone will sound. If an error was made during entry, an error tone will sound.

When an intercom call rings a busy station (w/intercom btn):

- » The CALLING station receives a ringback tone instead of a busy signal. The "called" station hears a muted or reminder ring and their intercom button LED flashes at the incoming CO line rate. (This indicates an incoming intercom call.)

- » The CALLED station can place the current CO call on hold by pressing the HOLD button,
-or-
They can place the current intercom call on hold by pressing the HOLD button. The intercom call is placed on hold on the available intercom button.
- » The CALLED station then presses the flashing intercom button to answer incoming intercom call. When answered, the following message displays on the called station LCD:

CALL FROM STA XXX MMM DD YY HH:MM am
--

Sta XXX can be a programmed station name.



SINGLE LINE TELEPHONE

Not applicable

Intercom Calls

To place an Intercom Call:

1. Press the *pre-programmed* DSS button of the party to be called, or dial the extension number.

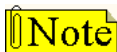

Dialing a number in the numbering plan activates the telephone automatically.

(You will hear ringing if the called station is in the T mode; or three bursts of tone if called station is in H or P mode.)

2. Lift the handset, or use speakerphone after tone bursts stop.
3. Hang up to end the call.

To answer an Intercom Call:

In the T mode ... you will hear repeated bursts of intercom tone ringing and the HOLD button flashes slowly.

Lift the handset or press the ON/OFF button to answer,

-or-

Position the H-T-P switch to the H mode to reply.

In the P mode ... you will hear three bursts of tone and one-way announcement. calling party cannot hear other conversations.

Lift the handset or press the ON/OFF button to answer,

-or-

Position the H-T-P switch to the H mode to reply.

In the H mode ... you will hear three bursts of tone and an announcement.

Reply handsfree or lift the handset for privacy.



SINGLE LINE TELEPHONE

To place an intercom call:

1. Lift the handset and dial the intercom number. You will hear ringing if called station is in "T" answering mode or two bursts of tone if called station is in "H" or "P" mode.
2. Hang up to end the call.

To answer an intercom call:

Lift the handset,

-or-

If your SLT is equipped with a speakerphone, press the Speaker button to converse in a handsfree mode.

Intercom Transfer

To use Intercom Transfer without DSS Buttons:

1. Receive or make an intercom call.
2. Press TRANS, an intercom dial tone will sound.
3. Dial the desired station number.
4. When the second station answers, you are in a supervised transfer mode (first station is staged for transfer).
5. Hang up (stations 1 and 2 will be connected).

To use Intercom Transfer with DSS Buttons:

1. Receive or make an intercom call using a DSS button.
2. Press TRANS, an intercom dial tone will sound.
3. Press the DSS button where to transfer the call.
4. Hang up (stations 1 and 2 will be connected).

Keypad Mode

This feature allows you to determine the mode and baud rate of the optional CTI Module connected to your phone. This setting is stored in back-up memory in the case of a power outage or system reset. When telephone is set to AT command mode, these AT commands are supported.

Mode	Description
Inactive	No CTI information is sent/received by the telephone.
ATD	Modem Dialing Command -- The telephone will recognize the ATD and accept digits after the command.
ATH or ATHX (X= 0 or 1)	Modem On-Hook/Off-Hook Command -- ATH or ATH0 will force the telephone to go to the on-hook state from its current state. ATH1 will force the telephone to go to the off-hook state from its current state.
CKTU	Command used with Wanderer (a cordless key telephone unit). The baud rate is not used in this mode; no change is necessary.
PC Phone	CTI information used with <i>Discovery Desktop</i> and <i>Discovery PCPhone</i> software must be set to 4800 baud rate.
SPI	Service Provider Interface -- Command used with TAPI applications such as <i>Discovery Link</i>

At an idle station:

1. Dial the Keypad Mode code [648] on the dial pad,
-or-
Press the *preprogrammed* KEYPAD MODE button, the following message displays:

INACTIVE	2400
MODE=* SAVE=HOLD BAUD=#	

2. Press [*] to scroll through the keypad modes.
3. Press [#] to scroll through the baud rates.
4. Press HOLD to save the desired entries.



SINGLE LINE TELEPHONE

Not applicable

Last Number Redial



The Last Number Redial (LNR) feature permits the automatic redialing of the last telephone number dialed on an outside line. Up to 24-digits can be stored. Outside line selection of the same line used is automatic.

To use Last Number Redial, either:

1. Press SPEED.
 2. Press [#].
- or-
Use the Soft Key's LNR option when in an idle condition.

The system automatically selects the original line used to place the call and redials the last number dialed.

- If that line is busy, the system will select another line from the same group and redial the number.
- If no lines are available in the same group, you will receive a busy tone and can queue for a line.
- If you preselect a line before activating LNR, the preselection will override the line used originally.



SINGLE LINE TELEPHONE

Not applicable

LCR Operation

To place an outside call when LCR is enabled in the system:

1. Dial [9] on the dial pad or press *preprogrammed* LCR button.
2. Dial the desired telephone number.
3. Wait for an answer. Then lift the handset or use the speakerphone to converse.

If all available lines are busy, remain off-hook for four seconds to automatically be queued onto LCR for an available line, then hang up.

To answer an LCR Queue Call Back:

1. When your telephone is signaled, answer the call.
2. The telephone number will be automatically redialed.

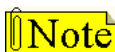

Only one LCR Queue Call Back request may be initiated by a station. When a second request is made, the first request is cancelled.

If the 911 feature is enabled, the LCR access code is 800 instead of 9.

To cancel a CO Line Queue Call Back Request:

1. Dial the CO Line Queue Cancel code [626] on the dial pad.
 2. Replace the handset, or press the ON/OFF button.
-

Loop Key



A station not having a direct appearance for a CO line will receive incoming CO calls and transferred CO calls under the LOOP button. Only one call at a time can be connected to a keyset on the LOOP button.

To make a Loop button:

1. Press SPEED + SPEED.
 2. Press the desired flexible button.
 3. Dial [89], then press HOLD.
-

Mailbox Buttons



To program a station's mailbox on a flexible button:

1. Press SPEED + SPEED.
2. Press the desired flexible button to be programmed.
3. Dial the mailbox feature access code (460-467 = VM Grp 1-8).
4. Dial the VMID number. A confirmation tone will sound. If an error is made during entry, an error tone will sound.

Example ... 4606037 represents a voice mail button (group 1) for VMID 6037 that is in the system with the centralized voice mail installed.

To use a mailbox button:

The called station presses the MAILBOX flexible button and goes on-hook. The internal or external call is then transferred to the VM port by the telephone system.

Message Wait



OR



Stations that are busy, unattended and ringing, or in DND can be left a message indication by other stations in the system. Up to five messages can be left at one keyset. Upon return to the station, the user can answer the message waiting indication of each party in sequential order.

To leave a message waiting indication:

1. Lift the handset, or press the ON/OFF button.
2. Dial the desired intercom station.
3. Press the MSG button or use the Soft Key's MSG option. A confirmation tone will sound. The called party's MSG button will flash slowly.
4. Replace the handset or press ON/OFF button to end the call.

To answer a message waiting indication:

If your MSG button is lit and/or you have an LCD display of "MSG: XXXX", you have a message waiting for you. The first message left is the first one called.

1. Press the MSG button or dial [663]. The station that left message will be signaled with tone ringing.
2. If the called station does not answer, press the MSG button once if you want to leave that station a message waiting indication.



SINGLE LINE TELEPHONE

To leave a message waiting indication:

1. Lift the handset and dial the desired intercom station.
2. If you do not receive an answer, or a DND tone sounds, press FLASH.
3. Dial [623].
4. Hang up.

To answer a message waiting indication:

You have a message waiting when your message waiting lamp is flashing, or an interrupted dial tone when lifting the handset.

1. Lift the handset.
2. Dial [663]. The station that left message will ring.

Modem

Voice Mail Modem Access

You can program Vodavi voice mail systems using the telephone system modem.

To access the voice mail system, you can either:

Dial [498], ring directly to 498, be transferred to 498.

Telephone System Modem Access

Feature code 499 is used for access to the telephone system modem. This modem allows remote telephone system programming via an SLT or externally by having a call transferred to extension 499. COs and DIDs (if applicable) can also be programmed to ring directly to extension 499.

Mute

Pressing the MUTE button while in the speakerphone mode or using the handset disables the microphone but does not affect the speech coming over the speaker or handset. Pressing the illuminated MUTE button again reactivates the microphone.

To disable the microphone:

1. Press MUTE while off-hook on speakerphone or handset to activate.
2. Press MUTE again to deactivate. Mute automatically deactivates upon call termination.

Name In Display

Every extension (Key or SLT) has the capability to program your name so that people using display telephones will see your name instead of your station number.

To create your name:

1. Dial [690] on the dial pad.
2. Use dial pad keys to enter your name (up to 7 characters).

1	A - 21 B - 22 C - 23	D - 31 E - 32 F - 33	Other Codes			
G - 41 H - 42 I - 43	J - 51 K - 52 L - 53	M - 61 N - 62 O - 63	1 = 1#	8 = 8#	" = 01	* = *#
P - 71 R - 72 S - 73 Q - 74	T - 81 U - 82 V - 83	W - 91 X - 92 Y - 93 Z - 94	2 = 2#	9 = 9#	, = 02	(= #1
*	OPER 0	#	3 = 3#	0 = 0#	? = 03) = #2
			4 = 4#	Space = 11	/ = 04	+ = #3
			5 = 5#	: = 12	! = *1	= = #4
			6 = 6#	- = 13	\$ = *2	# = ##
			7 = 7#	' = 14	& = *4	. = 24

3. Press SPEED to complete programming process.

To erase your name:

1. Dial [690] on the dial pad.
2. Press SPEED to complete the erasing process.



SINGLE LINE TELEPHONE

To create your name:

1. Dial [690] on the dial pad.
2. Enter the name (up to 7 characters) using dial pad keys.
3. Press the FLASH button to complete the programming process.

To erase your name:

1. Dial [690] on the dial pad.
2. Press the FLASH button to erase.

Night Service



To enter Night Service Mode, from an idle station:

Press the *preprogrammed* NIGHT SERVICE flexible button [604]. The system is now in the Night Service Mode.

To remove Night Service Mode:

Press the *preprogrammed* NIGHT SERVICE flexible button [604] again. System is removed from the Night Service Mode.

Off-Hook Voice Over (OHVO)



OR



While off-hook on a call (CO or Intercom), this feature allows you to receive a voice announcement through the handset receiver without interrupting the existing call. You may then respond to the calling party using CAMP ON procedures to talk to the calling party or use Silent Text Messaging to respond to the calling party via LCD Displays.

The calling station is placed in a one-time DND mode upon initiating the voice-over. One-Time DND cannot be toggled during the OHVO call. The station receiving the OHVO call must be off-hook and in the "H" mode.

To place an Off-hook Voice Over call:

When an OHVO station calls a busy OHVO station and a busy tone is received, the calling OHVO station must:

Press *preprogrammed* OHVO button [628] or use Soft Key OHVO to initiate OHVO announcement, the following occurs:

- The HOLD button LED flashes at called OHVO station.
- The OHVO receiving station receives a one-beep warning tone. The station receiving the OHVO call must be off-hook and in H or P mode, then the calling OHVO party may begin the voice announcement to the called OHVO party. The called OHVO station's existing conversation is uninterrupted and the voice over announcement does not drown out the existing conversation. If the receiving station is call forwarded, use [5#] to override forwarding.
- The calling OHVO station is not connected or able to hear the called station's conversation (connection only allows calling station to transmit to the called station).



The calling station is placed in a one-time DND mode upon initiating the Voice Over. One-Time DND cannot be toggled during the OHVO call. The station receiving the OHVO call must be off-hook and in H mode.

To respond to an Off-hook Voice Over:

After receiving an OHVO announcement, **three options** are available to respond to the caller:

Option 1 -- allows the receiving station to respond to an OHVO announcement using the MUTE feature button. This button is pressed to carry on a two-way conversation with the OHVO initiator while still listening to the original call.

Option 2 -- allows the OHVO receiving station to respond to the calling station by using Silent Text Messaging (only available to digital telephones, and the calling station must have a digital display). The OHVO receiving station can press a *preprogrammed* Message button to respond to the voice over announcement without being released from the current call (e.g., by pressing a flexible button *preprogrammed* for the message IN MEETING, the calling station receives this message on the LCD display).

Option 3 -- allows the OHVO receiving station to respond to the calling OHVO station by using the Camp On feature. The OHVO receiving station presses the flashing HOLD button to consult with the calling station. The existing call (CO line) goes on Exclusive Hold automatically. This method then follows the Camp On procedures.



SINGLE LINE TELEPHONE

Not applicable

Outside Calls



Placing an Outside Line on Hold

If Exclusive Hold Preference is programmed, press HOLD for Exclusive Hold, or HOLD + HOLD for System Hold.

-or-

If System Hold Preference is programmed, press HOLD for System Hold, or HOLD + HOLD for Exclusive Hold.

Answering a Recall

When an outside line has remained on hold for an extended period of time, you are reminded with a recalling ring. (If Preferred Line Answer is enabled, skip step 1.)

1. Press the OUTSIDE LINE, LOOP, or POOL button (flashes at a very fast rate).
2. Lift the handset or press ON/OFF to converse with the party.

Answering an Outside Call

1. Lift the handset, or press the ON/OFF button.
2. Press slow flashing OUTSIDE LINE button or LOOP button.
 - » If Preferred Line Answer is programmed, you may answer an outside line by lifting the handset, or pressing the ON/OFF button.

Placing an Outside Call

To access an outside line for dialing out:

1. Press idle CO line button, POOL button,
-or-
Dial access code: 9, 801-823, 88+LLL. (LLL = CO Line Number)
2. Dial number for outside call.

- Lift the handset, or use speakerphone to converse with party.

Paging



If you are given the ability to make page announcements:

- Lift the handset, or press the ON/OFF button.
- Dial a three-digit paging code,
-or-
- Press the *preprogrammed* PAGING flexible button.
-or-

Use the Soft Key's ALLPG IN or ALLPG EX options (versus codes 709 or 761) when in an idle condition.

Code	Zone	Code	Zone
700	Int/Ext All Call	706	Internal Zone 6
701	Internal Zone 1	707	Internal Zone 7
702	Internal Zone 2	708	Internal Zone 8
703	Internal Zone 3	709	Internal All Call
704	Internal Zone 4	761	External Page Zone
705	Internal Zone 5		

- Speak in a normal tone of voice to deliver the message.
Stations receiving a page Announcement can press the Volume Bar to change Paging Volume. The display shows:

SPEAKER PAGE [#####]
MMM DD YY HH:MM am

5. Replace the handset to terminate the page announcement.

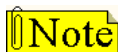

Stations off-hook or in DND will not hear the page announcement.

Paging - Meet Me

To request another party meet you on a page:

1. Dial the desired three-digit paging code.
2. Request the party to meet you on the page.
3. Do not hang up; wait for the requested party to answer.

To answer a Meet Me Page:

1. Go to the nearest phone.
2. Dial [770] or press the *preprogrammed* MEET ME flexible button. You will be connected to party that paged you.

Personalized Messages

Pre-assigned Messages

Each station can select a pre-assigned message to display on the LCD of any key telephone calling that station. There are ten messages available.

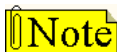

This feature is unavailable at Attendant stations. Stations cannot be call forwarded or in DND and have this feature active.

To select a pre-assigned message:

1. Dial [633] on the dial pad,
-or-
Press the *preprogrammed* PERSONAL MESSAGES button.
2. Dial the 2-digit code for the message that displays. A confirmation tone will sound; DND button LED will flash.

00 = (clears msgs) 04 = Return Tomorrow 08 = At Home
01 = On Vacation 05 = Return Next Week 09 = On Break
02 = Return AM 06 = On Trip 10 = At Lunch
03 = Return PM 07 = In Meeting

To cancel a pre-assigned message:

1. Either dial the Personal Messages code [633] + [00], dial [662], or press the DND button.
2. Replace the handset. The DND button LED will extinguish.

Custom Messages

Each station can select from ten possible custom messages to display on the LCD of a key telephone calling that station. These messages are programmed from the first Attendant station for system-wide use.

Each station can also program three unique custom messages.

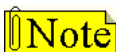

The Custom Messages feature is not available for use by Attendant stations.

To select a custom message:

1. Dial [633] on the dial pad, or press the *preprogrammed* PERSONAL MESSAGES button.
2. Dial a valid message number (21-30) for the desired custom message.

The 1st Attendant should provide a list of messages to each station user.

To program a unique custom message:

1. Dial [633] on the dial pad.
2. Dial a valid message number (18-20) for the desired custom message.
3. Enter a custom message, up to eight characters.
4. Press HOLD to save the message.

To use a unique custom message:

1. Dial [633] on the dial pad, or press the *preprogrammed* PERSONAL MESSAGES button.
2. Dial a valid message number (18-20) for the desired custom message.

To cancel a custom message:

1. Either dial the Personal Messages code [633] + [00], dial [662], or press the DND button.
2. Replace the handset. DND button LED extinguishes.



SINGLE LINE TELEPHONE

SLT users can use custom messages (21-30) as described above. Unique custom messages (18-20) are not applicable. SLT users cancel the use of a custom message by using feature code 662.

Date and Time Entry Messages

Station users can activate certain messages that let users enter a specific time or return date. These messages appear on the calling station's display to alert them of the desired party's return time or date.

To activate a message with a custom return time or date:

1. Dial the Message Access code [633] on the dial pad.
2. Then dial the desired message number [11- 17].

Users may activate the following messages and be prompted to enter a return time or date:

- [11] = Vacation Until: MM/DD
- [12] = Return: HH:MM xm or MM/DD
- [13] = On Trip Until: MM/DD
- [14] = Meeting Until: HH:MM xm
- [15] = At Home Until: HH:MM xm
- [16] = On Break Until: HH:MM xm
- [17] = At Lunch Until: HH:MM xm

3. Enter the date/time on the dial pad as shown:

			Other Codes			
1	A - 21 B - 22 C - 23	D - 31 E - 32 F - 33	1 = 1#	8 = 8#	" = 01	* = *#
G - 41 H - 42 I - 43	J - 51 K - 52 L - 53	M - 61 N - 62 O - 63	2 = 2#	9 = 9#	, = 02	(= #1
P - 71 R - 72 S - 73 Q - 74	T - 81 U - 82 V - 83	W - 91 X - 92 Y - 93 Z - 94	3 = 3#	0 = 0#	? = 03) = #2
*	OPER 0	#	4 = 4#	Space = 11	/ = 04	+ = #3
			5 = 5#	: = 12	! = *1	= = #4
			6 = 6#	- = 13	\$ = *2	# = ##
			7 = 7#	' = 14	& = *4	. = 24

4. Press HOLD to enter the message. A confirmation tone will sound and the DND button LED will flash.

To cancel the message:

1. Either dial the Personal Messages code [633] + [00], dial [662], or press the DND button.
2. Replace the handset. The DND button LED will extinguish.



SINGLE LINE TELEPHONE

Not applicable

Scrollable Canned Messages



The Scrollable Canned Message feature allows you to use a single digit [#] or [*] to scroll through the canned messages and select one. When the desired message is displayed, pressing the hold button places that message on the station LCD. This feature operates when the phone is in the idle mode only. This feature cannot be activated if the station is in the Call Forward or DND mode(s). This feature is not available to Attendant stations.

To select a Scrollable Canned Message:

1. Dial [633]+[#] on the dial pad,

-or-

Use the Soft Key's PERS-MSG option.

-or-

Press the PERSONAL MESSAGES button. Clear Messages is always first. The following message displays:

CLEAR MESSAGES
NEXT=# PREV=* SAVE=HOLD

2. Press [#] to scroll through the messages or press [*] to scroll backward through the list.
3. Scroll forward through the messages in the following order. The scroll is a rolodex-type scroll.

1 - (Clear Messages)	7 - On Vacation
2 - At Home	8 - Return AM
3 - At Lunch	9 - Return PM
4 - In Meeting	10 - Return Next Week
5 - On Break	11 - Return Tomorrow
6 - On Trip	
4. When the desired message displays on the LCD, press HOLD to activate that message on your station. A confirmation tone will sound, and the DND button LED will flash.

To cancel the message:

1. Either dial the Personal Messages code [633] + [00], dial [662], or press the DND button.
2. Replace the handset. The DND button LED will extinguish.



SINGLE LINE TELEPHONE

Not applicable

Personal Messages Flexible Button

You can program the code [633] onto a flexible button to speed access to select and use messages.

To program the Personal Messages Flexible Button:

1. Press SPEED + SPEED.
2. Press the desired flexible button. The LED will flash.
3. Dial [633]+[#] on the dial pad; confirmation tone will sound.

To use the flexible button, press that flexible button, then:

Dial the 2-digit message number (00-10 or 18-30) to activate the message. A confirmation tone sounds and DND button LED flashes.

-or-

Press [#] or [*] to scroll through the list.

When the desired message is shown on the LCD, press HOLD to activate that message on your station. A confirmation tone will sound; the DND button LED will flash.



SINGLE LINE TELEPHONE

Not applicable

PBX/Centrex Codes on a Flex Button



For one-button access to Centrex or PBX features:

1. Program Centrex or PBX code into a Station or System Speed Dial bin, including hook-flash (FLASH key), [*], and [#] commands (refer to [“Speed Dial” on page 79](#)).
2. Program that speed bin onto a flexible button (refer to [“Flexible Button Programming” on page 47](#)).

Release Button



The Release Button feature allows the station user to speed up call handling time by disconnecting calls while being off-hook.

Using the handset, while off-hook (not the speakerphone):

Press the *preprogrammed* RELEASE button [641] to terminate an intercom call, transfer sequence, page announcement, or CO call.

Redial

Last Number Redial



To use Last Number Redial, either:

1. Press SPEED.
2. Press the pound [#] key. The last number dialed over an outside line will be automatically redialed.

-or-

Use the Soft Key's LNR option when in an idle condition.

Save Number For Redial

If you wish to save the last number you dialed, either:

1. After placing an outside call, keep the handset off-hook.
2. Press SPEED + SPEED,

-or-

Use the Soft Key's STORE NO option.

Redial a Saved Number

To dial a number that was saved for redial, either:

Press SPEED, then press the [*] key.

-or-

Use the Soft Key's SNR option when in an idle condition.

The saved number is automatically dialed.

Repeat Redial

When you place a CO call and a Busy or No Answer is received:

1. Press the *preprogrammed* RPT REDIAL flexible button [643]. You will receive an LCD prompt for a timer value.

ENTER RPT REDIAL TIMER:
XXX 006-999

2. Enter a valid number (006-999 seconds) for the Repeat Redial Timer. The default value is 060 (one minute). A confirmation tone will sound when you go on-hook. The flexible button LED will be lit steady.

When the timer expires, you will receive a signal via a CO line queue indication on the RPT REDIAL flexible button. During the Queue Call Back, the LCD display will indicate that this is a Redial Call Back. Once the line queue is answered, the LCD will indicate an outgoing CO line.

To activate a redial:

Press the *preprogrammed* REDIAL flexible button,

-or-

Press the ON/OFF button,

-or-

Lift the handset, the line will be seized and the number is dialed. If you receive a busy/no answer, you may repeat the step to activate another redial.

To cancel the operation:

Press the *preprogrammed* REDIAL flexible button. A confirmation tone will sound and Auto Redial is cancelled.



SINGLE LINE TELEPHONE

Not applicable

Ring Down / Hot Line / Off-Hook

Preference



If your phone has been programmed for Off-Hook Preference, you can access an outside line, or a feature by going off-hook or pressing the ON/OFF button. It simulates the depression of a specific button and can be programmed by a station user or a database administration programmer using code [691] + the button number.

While Off-Hook Preference is enabled, you may access internal intercom dial tone as follows:

1. Press the *preprogrammed* ICM button,
-or-
Dial your intercom number. (Do not lift the handset or press the ON/OFF button before dialing intercom number.) The LED will light steady and an intercom dial tone will sound.
2. Dial an internal station or feature access code.

Off-Hook Preference Programming (Via a Station)

If your phone is programmed for Off-Hook Preference and you have the ability to enable or change the Prime Flexible Button:

Dial [691] on the dial pad, then dial the desired button number. Refer to the following chart:

*	01	*	02	*	03	*	04
*	05	*	06	*	07	*	08
*	09	*	10	*	11	*	12
*	13	*	14	*	15	*	16
*	17	*	18	*	19	*	20
*	21	*	22	*	23	*	24

To disable Off-Hook Preference:

Dial [691] on the dial pad, then dial [00].



SINGLE LINE TELEPHONES

Single line telephones can bypass Off-hook Preference by pressing the FLASH button and then dialing their extension number.

Ring Tone

To select a distinctive ring tone for a station:

1. Dial Ring Tone program code [695]. The following displays:

ENTER RING TONES	00-36
XX PRESS SPEED TO SAVE	

2. Enter a valid tone number. The speaker will sound a steady tone that correlates to the 2-digit entry. The 2-digit tone number will display in the lower left corner of the LCD.

The ringing choices are as follows:

CO RING TONE*/FREQUENCY					
Tone (#)	Freq	Tone (#)	Freq	Tone (#)	Freq
00	697/770	13	770/1633	26	1209/1336
01	697/852	14	770/0	27	1209/1477
02	697/941	15	852/941	28	1209/1633
03	697/1209	16	852/1209	29	1209/0
04	697/1336	17	852/1336	30	1336/1477
05	697/1477	18	852/1477	31	1336/1633
06	697/1633	19	852/1633	32	1336/0
07	697/0	20	852/0	33	1477/1633
08	770/852	21	941/1209	34	1477/0
09	770/941	22	941/1336	35	1633/0
10	770/1209	23	941/1477	36	OFF
11	770/1336	24	941/1633	Tone Duration* = 50 ms/50 ms	
12	770/1477	25	941/0		

3. When the desired tone is selected (default ringing code is set to 00), press SPEED to save it as the tone to present to callers. A confirmation tone will sound.

School Zone

Description

The School Zone feature allows a person at a station(s) specified as an Administrator to control incoming calls for all stations specified as a Classroom. The Administrator controls the type of call forwarding and the call forwarding destination. Call forwarding types include All Call Forward, No Answer Call Forward, Busy Call Forward, and Busy / No Answer Call Forward. Valid call forwarding destinations include station numbers, hunt groups, UCD groups, and Voice Mail groups.

Stations to be included as part of the School Zone feature must be assigned in Admin programming as either an Administrator station or as a Classroom station. After these assignments have been established, the Administrator can easily control call forwarding for the specified Classroom stations by using feature code 630.

Operation

To control School Zone call forwarding (at an Administrator station):

1. Dial [630] + a call forward condition code (0 or 6-9) + a valid destination number.

Call Forward Condition Codes:

0 = Disabled

6 = All Call Forward

7 = No Answer Call Forward

8 = Busy Call Forward

9 = Busy / No Answer Call Fwd

Valid Destinations:

Station Numbers

Hunt Groups

UCD Groups

Voice Mail Groups

2. Press [HOLD], a confirmation tone will sound.

To view call forwarding status of Classroom telephones:

1. The Administrator uses a station assigned as an Administrator station and dials feature code [630] + [#].
A confirmation tone sounds and the LCD updates to show one of the following displays:

CLASSROOM STATUS BSY FWD TO XXXX
CLASSROOM STATUS NA FWD TO XXXX

CLASSROOM STATUS B/NA FWD TO XXXX
CLASSROOM STATUS FWD TO XXXX

2. Press the ON/OFF button to return to an idle status.

Conditions

- » A station can be assigned as an Administrator or as a Classroom, but not as both.
- » A call from an Administrator station to a Classroom station overrides any School Zone call forward settings and the call rings at the Classroom station.
- » School Zone call forwarding overrides station user call forwarding and DND.
- » If an E-911 button is programmed, both audible and visual alert indications will be provided, regardless of School Zone call forward settings.
- » The School Zone call forwarding feature does not apply to a Classroom station that is in a hunt group or a UCD group.

Speakerphone

1. Press ON/OFF button to ON; an intercom dial tone will sound.
 2. Press the DSS key of the desired party or press an available OUTSIDE LINE button and dial the number. The speakerphone will be activated.
 3. Press the ON/OFF button to end the call.
-

Speed Dial



A keyset user can associate up to 20 frequently dialed numbers as Station Speed Numbers (*9000-9019*). Telephone numbers can be up to 24 digits including pauses, flash commands, pulse-to-tone switchover, and non-display characters. A pause is automatically inserted after a flash.

To use speed dial:

1. If an outside line was not specified in programming, one can be selected now or the system will assign the line.
2. Press SPEED and dial the speed bin location,
-or-
Press the *preprogrammed* speed bin button,
-or-
Use the Soft Key's SPD option and then dial a speed bin location when in an idle condition.

To store speed dial numbers:

1. Press SPEED.
2. Press an OUTSIDE LINE button or the POOL button.
-or-
Select an outside line by pressing the SPEED button again.
3. Dial the speed bin location.

4. Dial the telephone number and include these special codes:
 - TRANS Initiates a Pulse-To-Tone switchover
When used as the first entry in the speed bin, this inserts a non-display character causing numbers stored in the bin not to appear on the digital telephone's display when bin is accessed.
 - HOLD Inserts a Pause
 - FLASH Inserts a Flash into the speed number
5. Press SPEED, then replace the handset to end speed bin programming.

To program multiple speed numbers:

1. Press SPEED + SPEED to conclude programming a number.
2. Enter the next speed number bin to program.

If the station has no line appearance for the line programmed into the speed bin, that line comes up under the LOOP button or POOL button when accessed.

To erase an existing speed bin:

1. Press SPEED + SPEED.
2. Dial the speed bin location.
3. Then press SPEED again. A confirmation tone will sound.



SINGLE LINE TELEPHONE

To use speed dial:

1. Lift the handset and dial [668] on the dial pad.
2. Dial a station or system speed bin number (9000-9099).
3. Replace the handset to end the call.

To store speed dial numbers:

1. Lift the handset and dial [661] on the dial pad.
2. Dial the desired station speed number (9000-9019).
3. Dial the telephone number to store.

4. Press the FLASH button. A confirmation tone will sound.

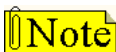

Line Group 1 is programmed along with SLT speed numbers, and thus Line Group 1 is used when activating station speed dial from an SLT.

System Speed Dial Access

Stations can be individually allowed or denied the ability to use system speed dial (9020-9099) numbers. (System speed numbers 9060-9099 are not monitored by toll restriction.) Stations cannot be prevented from using station speed dial.

The first programmed Attendant must enter the System Speed numbers (9020-9099). If an Attendant was not specified, system speed numbers are entered at Station 100.

Station/Port Fixed Number

When a station dials the feature code 611 on a display telephone, it will display the Fixed Station/Port Number for that telephone.

For example ... when using flexible numbering some programming steps require the "FIXED" code.

This code will allow you to dial 611 and quickly determine the fixed port.

STATION PORT:
XXX



SINGLE LINE TELEPHONE

Not applicable

Station Relocate

The Station Relocation Feature allows you to dial a code followed by the old station number to bring all the station attributes including extension number, button mapping, speed dial, and class of service to the new location.

1. A station can be relocated by unplugging it, then plugging it into a new location.
2. Dial [636], then dial the extension number of the station being relocated. Once this is done, all station attributes are copied to the current station.

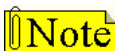

If a station is assigned to a specific port and that station user unplugs their station and plugs it in at another location, the database administration programming is updated to reflect the new port change. Station lock will prevent this feature from working correctly.



SINGLE LINE TELEPHONE

Not applicable

Text Messaging (Silent Response)

The Text Messaging feature allows you to use text messages to respond to a caller that has either Camped On or has used the off-hook voice over (OHVO) feature to alert a busy station of a waiting call or message. The Camped On station may respond to the caller via the canned, custom, and silent response text (LCD) messages. Text messages appear on the calling party LCD display. The calling (originating) station and receiving station MUST be digital telephones. The receiving station MUST also be programmed to allow OHVO calls.

While receiving a Camp On or OHVO call:

The called party may press a *preprogrammed* Text Message button with a specific message [633+XX].

For example ... [633] + [38] means a telephone calling the station receives the message WHO IS IT ?

Code	Text Message	Code	Text Message
31	I Will Take Call	42	Is It Important?
32	Take Message	43	Is It Urgent?
33	Transfer To Secretary	44	Send Call To Voice Mail
34	Put Call On Hold	45	Park Call
35	Call Back	46	Out Of Office
36	One Moment Please	47	Put Call Through
37	I Will Call Back	48	I Am Busy
38	Who Is It?	49	O.K.
39	Is It Long Distance?	50	No
40	Is It Personal?	51	Yes
41	Is It An Emergency?		



SINGLE LINE TELEPHONE

Not applicable

Uniform Call Distribution

The Uniform Call Distribution (UCD) features are described in the following sections.

UCD Calls In Queue Display

From an idle display key telephone:

1. Dial [567] followed by the UCD group number (55X),
-or-

Press the *preprogrammed* flexible button. The ON/OFF button LED lights steady.

- This idle display prompts a Supervisor that a group is having problems answering their calls.
 - The display tells the agent and their supervisor how many calls are in queue.
 - The agent automatically receives the calls in queue display whenever there is a call in queue.
2. Replace the handset or press the ON/OFF button to terminate the display.

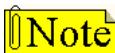

This feature cannot be used with a call in progress. The station is considered busy for incoming calls during this operation.

UCD Available/Unavailable Mode

If you are a UCD Agent, you can place your station in the Available mode to receive UCD type calls or in the Unavailable mode to block UCD calls from ringing to your station.

To enter Available Mode:

Dial [566] on the dial pad to start receiving UCD calls,

-or-

Press the *preprogrammed* AVAILABLE/UNAVAILABLE button.

To enter Unavailable Mode:

Dial [566] on the dial pad to block incoming UCD calls,

-or-

Press the *preprogrammed* AVAILABLE/UNAVAILABLE button.

UCD Overflow Station Forward

This feature allows UCD calls reaching the Overflow Station to call forward to another station:

1. Lift the handset, or press the ON/OFF button.
2. Press the FWD button or dial [640].
3. Dial the desired code:
[6] = All Calls [8] = Busy
[7] = No Answer [9] = Busy/No Answer
4. Dial the 3- or 4-digit destination number where calls are to be forwarded (Station, Voice Mail, UCD groups, Hunt group). A confirmation tone will sound.
5. Replace the handset, or press the ON/OFF button.

To remove call forwarding:

1. Lift the handset, or press the ON/OFF button.
2. Press the FWD button. A confirmation tone will sound and the FWD LED will extinguish.

UCD Wrapup End

An agent that wants to override the Wrapup Timer and immediately go back into an available UCD status can use a preprogrammed WRAPUP END flexible button.

To override the Wrapup Timer:

1. Preprogram a WRAPUP END flexible button using feature code 584.
2. Press the preprogrammed WRAPUP END flexible button.

Universal Day/Night Answer



Incoming CO lines can be programmed for Universal Day Answer (UDA) or Universal Night Answer (UNA). UDA/UNA assigned CO lines can also signal over the external page port(s). If External Day programming is enabled and the system is in the day mode, the assigned external page port(s) present a ringing signal. UDA/UNA is established on a per CO line basis in admin programming.

When the system is in Day or Night mode and an outside line rings at another station, and you wish to answer it:

Dial [#5] or use the Soft Key's UDA/UNA option. The connected outside line can be transferred or disconnected.

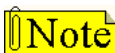

Each telephone using UDA/UNA must have a loop button appearance if the ringing outside line does not display at their phone.

Voice Mail

Call Forwarding to Voice Mail Groups

Callers may be routed directly to your mailbox by forwarding your phone to a voice mail group.

1. Lift the handset, or press the ON/OFF button.
2. Press FWD, or dial [640].
3. Dial the desired code:
[6] = All Calls [8] = Busy
[7] = No Answer [9] = Busy/No Answer
4. Dial the 3-digit Voice Mail group pilot number where calls are to be forwarded (440-447 = voice mail groups 1-8). A confirmation tone will sound.
5. Replace the handset, or press the ON/OFF button.

Retrieving Voice Messages



To enter the Voice Mail system to check for mail:

Dial the Voice Mail group number or press the
preprogrammed VM GROUP flexible button,

-or-

Press flashing MESSAGE WAIT button

-or-

Use the Soft Key's VM1 option (group 440 only).

(You will be prompted to enter your mailbox password.)

Voice Mail Transfer with ID Digits

While on a call and the caller on the other end wishes to leave a Voice Message for another VM user:

1. At the initiating station, press TRANS.
2. Dial the Voice Mail Group number or press *preprogrammed* VM GROUP flexible button.
3. Dial VMID (mailbox location) of desired party and go on-hook.

Voice Mailbox Button

To program a Mailbox flexible button:

1. Press SPEED + SPEED, then press the desired flexible button to be programmed.
2. Dial the Mailbox feature code (460-467 = VM locations 1-8).
3. Dial the VMID number.



SINGLE LINE TELEPHONE

Not applicable

Voice Mail Group Button

To program a VM GROUP flexible button:

1. Press SPEED + SPEED, then press the desired flexible button to be programmed.
2. Dial a 3-digit VM Group number (440-447=VM groups 1-8).
3. Dial the VMID number.

Voice Mail Group Access



To access a VM Group:

Dial VM Group number (440-447), or press *preprogrammed* VM Group flexible button,

-or-

Use the Soft Key's VM1 option when in an idle condition (to access group 440 only).

Voice Mail One-Touch Recording



OR



This “digital” voice mail feature allows a station user, while on an external call, to press a *preprogrammed* flexible button or Soft Key and have the system record a conversation in their mailbox.



Use of this feature when the One-Touch Recording Warning Tone is disabled may be interpreted as a violation of federal, state or local laws, and an invasion of privacy. Check applicable laws in your area before recording calls using this feature.

NOTE ... The “MiniVoice” system does not support One-Touch Record.

To make a VM RECORD flexible button:

1. Press SPEED + SPEED, then press the desired flexible button to be programmed.
2. Dial feature code [649] + [VVV]. (VVV = VM group 440-447).

While on an internal or external call:

1. Press the *preprogrammed* VM RECORD button or use the Soft Key's REC option (for VM Group 440 only). The LED will flutter red during the setup and the following message will display:

RECORDING SETUP MMM DD YY 00:00 am
--

2. Once the system makes the connection, your mailbox and the flexible button LED will light solid green. The LCD will display the following message:

RECORDING MMM DD YY 00:00 am
--

3. When you finish recording, press the *preprogrammed* VM RECORD button or the Soft Key's STOP option. The LED will extinguish and the normal LCD call information will display.



SINGLE LINE TELEPHONE

Not applicable

Voice Mail (Flash-Based) Quick Reference

----- MAIN MENU -----

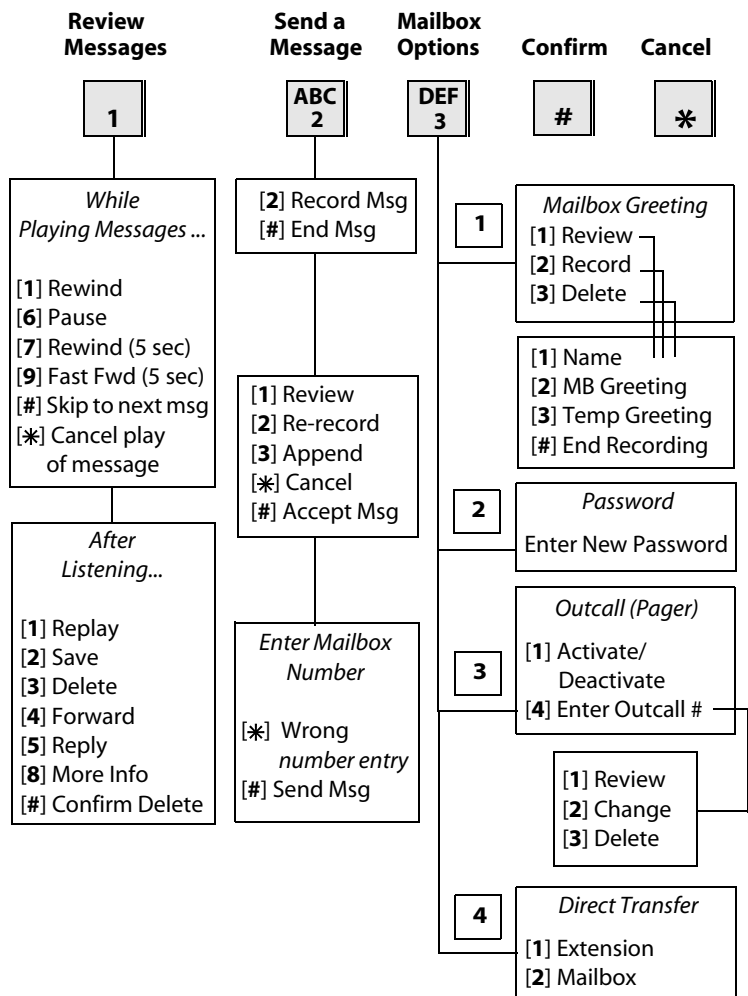

Voice Mail (Flash-Based) Quick Start

The following is a quick start procedure for first-time users:

1. Obtain System Administrator information:
 - » Voice mail system access number
 - » Your mailbox number
 - » Your temporary password
2. Dial voice mail system access number,
-or-
Call into the Auto Attendant, then
press **#** and enter your mailbox number.
3. After prompt, enter temporary password.
4. Press **3** to access Mailbox Options.
5. Press **2** to access Passwords.
6. After prompt, enter new password.
7. Press **1** to access Greeting Options.
8. Press **2** to select the Record option.
9. Press **1** to record your Name.
10. Press **2** to record your Greeting, then
press **#** to end recording.

Voice Mail (Hard Drive-Based) Quick Reference

----- MAIN MENU -----

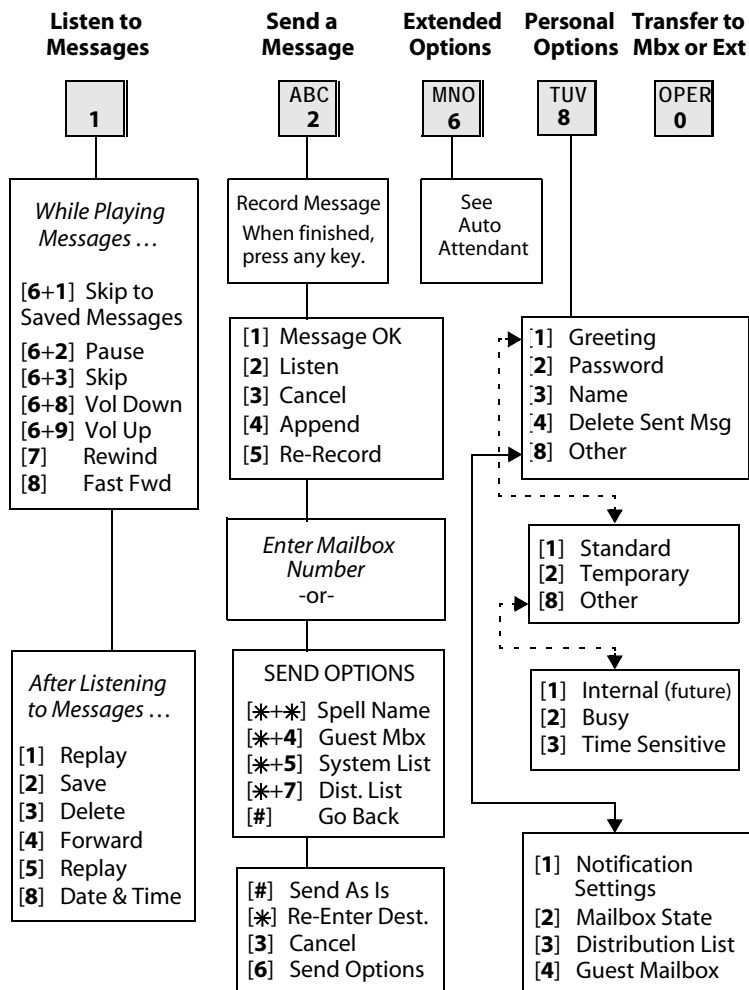

Voice Mail (Hard Drive-Based) Quick Start

The following procedure will assist first-time users:

1. Obtain System Administrator information:
 - » Voice mail system access number
 - » Your mailbox number
 - » Your temporary password
2. Dial voice mail system access number.
3. Once connected, enter your mailbox number.
4. After prompt, enter temporary password and press **#**.
5. Press **8** to access Personal Options.
6. Press **2** for Edit Password menu.
7. After prompt, enter new password; press **#** twice.
8. Press **3** for Edit Name menu.
9. Press **2** to record your name; press **#** when finished.
10. Press **1** for Record Greeting menu.
11. Press **1** again for Standard Greeting options.
12. Press **2** to record your greeting; press **#** to end recording.

Volume Control

The volume control on the Digital Key Telephone controls ringing, handset, and speakerphone volumes. It also affects the receive volume of the "Wandere" cordless unit.

Display Messages -- While using these function/features, Digital Key Telephones display the following messages:

Using the speakerphone
on an Intercom call ...

SPEAKER CALL	[#####]
MMM DD YY	HH:MM am

Using the handset on an
Intercom call ...

HANDSET ICM	[#####]
MMM DD YY	HH:MM am

Using the speakerphone
on a CO call ...

SPEAKER CALL	[#####]
MMM DD YY	HH:MM am

Using the handset on a
CO call ...

HANDSET CO	[#####]
MMM DD YY	HH:MM am

Receiving a page
announcement ...

SPEAKER PAGE	
MMM DD YY	HH:MM am

Receiving an incoming
tone ringing Intercom or
CO call ...

SPEAKER RING	[#####]
MMM DD YY	HH:MM am



SINGLE LINE TELEPHONE

The **volume control** on the Single Line Telephone is located on the right side of the telephone. The slider switch options are HI for loud volume, LO for low volume, and OFF to turn the ringer off. Two-line models have a volume switch for each line. Certain models do not have an OFF option.

Speakerphone models have a **sliding volume switch** to adjust speakerphone volume. Slide the switch toward you for lower volume or away from you for increased speakerphone volume.

Each model has a **volume button** that can be pressed to increase or decrease the handset volume.

The **B/Z ringer switch** is located on the bottom of the telephone near the line jacks. This switch should be set to the Z mode for business/hospitality applications and to the B mode for residential applications.

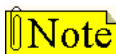

The MSG light and the Line In Use (LIU) LEDs will not operate when set in the B ringer mode.

























For single line telephones that are not equipped with a volume control slider switch or to increase the volume greater than that allowed by the slider switch, use the following steps.

While on a CO line call or an intercom call:

1. Press the FLASH button.
2. Dial [638].
3. Dial a valid number (0-9) to select a volume level.
-or-
Use [*] or [#] to scroll to increase or decrease volume level.
4. Press the FLASH button to return to the call.

Worksheets

24 Flexible Button Programming Worksheet

 1	 2	 3	 4
 5	 6	 7	 8
 9	 10	 11	 12
 13	 14	 15	 16
 17	 18	 19	 20
 21	 22	 23	 24

Speed Dial Bin Programming Worksheet

BIN 9000		BIN 9010	
BIN 9001		BIN 9011	
BIN 9002		BIN 9012	
BIN 9003		BIN 9013	
BIN 9004		BIN 9014	
BIN 9005		BIN 9015	
BIN 9006		BIN 9016	
BIN 9007		BIN 9017	
BIN 9008		BIN 9018	
BIN 9009		BIN 9019	

Default Numbering Plan

Function	Code	Digital	Attendant	SLT
911 Alert View/Del (reqs btn)	608/608+FLASH	•	•	
Account Code (reqs btn)	627	•	•	•
Answering Machine Ring	654+[0]	•	•	
Answering Machine Speaker	654+[1]	•	•	
Attnd	0	•		•
Attnd Clear Alarm (T-1)	606		•	
Attnd CO Line Ext (Off-Net) Fwd	603+[NNN]+[YYYY]		•	
Attnd Custom Message	694+[XX]+message		•	
Attnd Day/Night/Special (reqs btn)	631 (DND key)		•	
Attnd Directory List Programming	693		•	
Attnd Disable Outgoing CO Line	602+press CO line btn		•	
Attnd Override (reqs btn)	601		•	
Attnd Setting Time and Date	692+date & time		•	
Attnd Unavailable	607		•	
Attnd Voice Mail Alarm Clear	656		•	
Background Music	632+[0] or [1] (off/on)	•	•	
Call Back	622	•	•	•
Call Coverage - Non-Ring (reqs btn)	647+[XXX]	•	•	
Call Coverage - Ringing (reqs btn)	646+[XXX]	•	•	
Call Forward	640+[C]	•	•	•
Call Forward - External (Off-Net)	[640]+[*]+[YYYY]	•	•	•
Call Forward - Follow Me	642+[XXX]+[C]+dest	•	•	•
Call Park (location 1-8)	430-437	•	•	•

Function	Code	Digital	Attendant	SLT
Call Park - Personal	438	•	•	•
Call Park - Station	439+[XXX]	•	•	
Call Park Pickup - Station	#6+[XXX]	•	•	•
Call Park Pickup - System (location 1-8)	#430-#437	•	•	•
Call Pickup (reqs btn)	#0	•	•	•
Caller ID Display (Answered Calls)	659	•	•	
Caller ID Display (Unans Calls)	635	•	•	
Caller ID Name/Number (reqs btn)	653	•	•	
Calling Forward Override	5#+[XXX]+press[B]	•	•	•
Calling Sta Handsfree Mode Override	7#+[XXX]	•	•	•
Calling Sta Tone Mode Override	6#+[XXX]	•	•	•
Clear Call Fwd, DND, Personal Msg	662	•	•	•
CO Line (Idle) Direct Access	88+[LLL]	•	•	•
CO Line Grp Access Code (grp 1-23)	801-823	•	•	•
CO Line Grp Access Code (all grps)	824	•	•	•
CO Line Queue	621	•	•	•
CO Line Queue Cancel	626	•	•	•
Dial-By-Name	6*	•	•	
Directory Dial	680	•	•	
Do Not Disturb	631	•		•
DTMF Receiver Test	657	•	•	•
Executive Override	625	•	•	•
Flash (Centrex)	660			•
Headset Mode	634	•	•	
Hunt Group (group 1-8)	450-457	•	•	•
In and Out Button (reqs btn)	644	•		
Intercom Button (reqs btn)	645	•	•	

Function	Code	Digital	Attendant	SLT
Keypad Mode	648+[#,*]	•	•	
Last Number Redial	SPEED+[#]	•	•	
LCR (E911 active on CO Line)	800	•	•	•
LCR (if active) or CO Line Group 1	9	•	•	•
Loop Key (reqs btn)	89	•	•	
Message Wait Answer	663	•	•	•
Modem	499			•
Modem - Voice Mail Access	498			•
Name in Display	690	•	•	•
Night Service (reqs btn)	604	•	•	
Off Hook Voice Over (reqs btn)	628	•	•	
Page - All Call	700	•	•	•
Page - Ext Zone	761	•	•	•
Page - Internal Zones 1-8, All	701-709	•	•	•
Page - Meet Me (Answer)	770	•	•	•
Personal Messages	633+[ZZ]	•		•
Release Button (reqs btn)	641	•	•	
Repeat Redial	643	•	•	
Ring Down / Hot Line / Off-Hook Pref	691+[BB]	•	•	
Ring Tone	695+[RR]	•	•	
Save Number Redial	SPEED+[*]	•	•	
School Zone	630	•	•	•
SLT Conference Park	664			•
SLT Directed Call Pickup	#1			•
SLT Message Wait	623			•
SLT Speed Dial	668+[YYYY]			•
SLT Speed Programming	661+[YYYY]			•

Function	Code	Digital	Attendant	SLT
SLT Volume	638+[V]			•
Speed Dial	SPEED+[YYYY]	•	•	
Station Numbers (Fixed)	100-149	•	•	•
Station/Port Fixed Number	611	•	•	
Station Relocate	636+[XXX]	•	•	
Stop Trace	658	•	•	
UCD Avail/Unavail	566	•	•	•
UCD CIQ Sta Display (any grp)	567+[UUU]	•	•	
UCD Group (grp 1-16)	550-565	•	•	•
UCD Wrap-up End (reqs btn)	584	•	•	
Unanswered CO Call Transfer	639	•	•	
Universal Day/Night Answer	#5	•	•	•
Voice Mail Group (grp 1-8)	440-447	•	•	•
Voice Mailbox Btn (reqs btn)	460-467+[VMID]	•	•	
VM One Touch Record (reqs btn)	649+[VVV]	•	•	

TABLE LEGEND

B = Button w/ feature code:

- 622 = Call Back
- 620 = Camp On
- 625 = Exec Override
- 623 = Message Wait
- 628 = OHVO

BB = Button Number

C = Call Forward Condition Code

- 6 = All Calls
- 7 = No Answer
- 8 = Busy
- 9 = Busy / No Answer
- * = Off-Net (for Follow Me only)

LLL = COLineNumber(001-028);(001-012for STS Home systems

MMMM = 2- to 4-digit Mailbox Number

NNN = CO Line Group Access Code of group to be forwarded

801- 823 = CO Group 1-23

824 = All CO Groups

RR = Ring Tone Number (00-36)

V = Volume Control Level (0-9)

VVV = Voice Mail Grp Number (440-447)

XX = Custom Message Number (21-30)

XXX = Intercom Station Numbers

YYYY = Speed Dial Bin Numbers (9000-9099)

ZZ = Personalized Messages

